

The logo for 'igoto' features the brand name in a bold, white, lowercase sans-serif font. Below the 'o' is a stylized orange semi-circle. A registered trademark symbol (®) is positioned to the right of the 'o'.

**igoto**®

**CATÁLOGO DE  
PRODUCTOS**

**2022**

---

**ILUMINACIÓN/PLACAS/ARTEFACTOS/MECANISMOS/BOMBAS**

---



# ➤ ÍNDICE AXOLIGHT

<b>PLACAS</b>	<b>06-09</b>	LÍNEA INOX
<b>APAGADORES Y MECANISMOS</b>	<b>10-18</b>	LÍNEA LUGANO PLUS
	<b>19-26</b>	LÍNEA STYLE PLUS
	<b>27-29</b>	ZURICH PLUS
	<b>29-39</b>	APAGADORES Y MECANISMOS
<b>ARTEFACTOS Y PRODUCTOS ELÉCTRICOS</b>	<b>40-47</b>	ARTEFACTOS ELÉCTRICOS
	<b>48</b>	EXTENSIONES
	<b>49</b>	INTERRUPTORES TERMOMAGÉTICOS
	<b>50</b>	EXTRACTORES
<b>ILUMINACIÓN</b>	<b>51-52</b>	FOCOS LED E27
	<b>53-54</b>	PAQUETES FOCOS LED E27
	<b>55-56</b>	FOCOS LED ALTA POTENCIA
	<b>57-58</b>	FOCOS LED DICROICOS
	<b>59-60</b>	GABINETES
	<b>61-65</b>	REFLECTORES LED
<b>VENTILACIÓN</b>	<b>66-69</b>	VENTILADORES
<b>ILUMINACIÓN</b>	<b>70-71</b>	LÁMPARAS DE NOCHE
	<b>72-74</b>	REFLECTORES LED
<b>NUEVOS PRODUCTOS</b>	<b>06-09</b>	LÍNEA DE PLACAS INOX
	<b>53</b>	FOCO DE EMERGENCIA
	<b>53-54</b>	PAQUETE FOCOS LED E27
	<b>56</b>	FOCOS LED ALTA POTENCIA
	<b>61-65</b>	REFLECTORES LED
	<b>67</b>	VENTILADORES VENTALL



# ➤ ÍNDICE NOVATEK

**BOMBAS HIDRÁULICAS**

**PRESURIZADORES Y AUTOMÁTICOS**

**TANQUES HIDRONEUMÁTICOS**

**BOMBAS SUMERGIBLES**

**SOLDADORAS Y CARETAS**

**REFACCIONES**

<input type="checkbox"/>	<b>76-77</b>	BOMBAS PERIFÉRICAS
<input type="checkbox"/>	<b>78</b>	BOMBAS CENTRÍFUGAS
<input type="checkbox"/>	<b>77-78</b>	BOMBAS DUO
<input type="checkbox"/>	<b>79</b>	MOTOBOMBA
<input type="checkbox"/>	<b>80</b>	PRESURIZADORES
<input type="checkbox"/>	<b>80</b>	AUTOMÁTICOS
<input type="checkbox"/>	<b>81</b>	TANQUE HIDRONEUMÁTICO
<input type="checkbox"/>	<b>81</b>	TANQUES ARMADOS
<input type="checkbox"/>	<b>82-84</b>	BOMBAS SUMERGIBLES
<input type="checkbox"/>	<b>85-86</b>	BOMBA TIPO BALA
<input type="checkbox"/>	<b>87-88</b>	SOLDADORAS
<input type="checkbox"/>	<b>88</b>	CARETAS
<input type="checkbox"/>	<b>89-92</b>	REFACCIONES

**NUEVOS PRODUCTOS**

<input type="checkbox"/>	<b>85</b>	BOMBA TIPO BALA
<input type="checkbox"/>	<b>88</b>	SOLDADORAS PLUS



# ➤ ÍNDICE DE ÍCONOS IGOTO



	Acero inoxidable		Alberca		Aspersores		Batería recargable
	Clavija		Contacto aterrizado		Contacto polarizado		Fácil instalación
	Fácil instalación		Factor de protección		Garantía: 1 año		Garantía: 2 años
	Garantía: 3 años		Garantía: 10 años		Incluye tornillos		Índice de protección
	Índice de reproducción cromática		LED		Luz dimeable		No incluye baterías
	Norma Oficial Mexicana		No requiere cableado		Omnidireccional		Panel solar
	Policarbonato		Salida USB		Sensor de movimiento		Tinaco
	Tiempo de vida		Tipo de base: E26/E27		Tipo de base: GU10		Tipo de base: MR16
	Tipo de empaque: - Blister		Tipo de empaque: - Bolsa		Uso agrícola		Uso doméstico
	Voltaje						





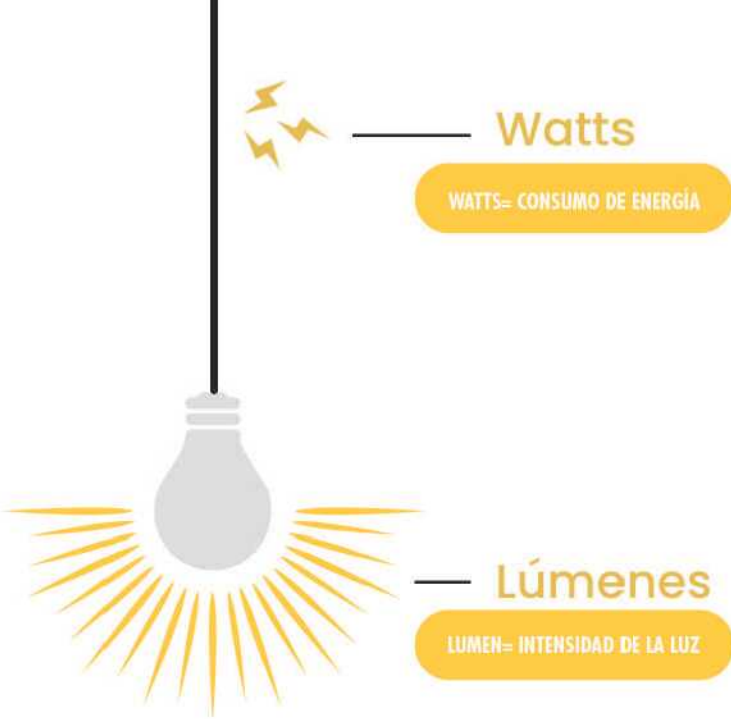

<b>WATTS</b> (CONSUMO DE ENERGÍA)	<b>LÚMENES</b> (INTENSIDAD DE LA LUZ)
Foco tradicional (10lm/watt)	Foco LED (100lm/watt)
<b>40 w</b> 0-450 lúmenes	<b>2-5 w</b> 0-450 lúmenes
<b>60 w</b> 500-850 lúmenes	<b>6-9 w</b> 500-850 lúmenes
<b>75 w</b> 900-1150 lúmenes	<b>11-14 w</b> 900-1150 lúmenes
<b>100 w</b> 1200-1650 lúmenes	<b>15-17 w</b> 1200-1650 lúmenes



**TEMPERATURA DE LA LUZ**

Luz Cálida	Luz Blanca	Luz Fría
2400-3000K	4100-5700K	6500-7000K

PRIMER DÍGITO (PROTECCIÓN CONTRA SÓLIDOS)	DEFINICIÓN	SEGUNDO DÍGITO (PROTECCIÓN CONTRA LÍQUIDOS)	DEFINICIÓN
<b>0</b>	Sin protección	<b>0</b>	Sin protección
<b>1</b>	Protegido contra objetos sólidos de más de 50 mm (contactos involuntarios con las manos)	<b>1</b>	Protegido contra caídas verticales de gotas de agua o condensación
<b>2</b>	Protegido contra objetos sólidos de más de 12 mm (contacto con los dedos)	<b>2</b>	Protegido contra caídas verticales de gotas de agua con una inclinación de 15° respecto a la vertical
<b>3</b>	Protegido contra objetos sólidos de más de 2.5 mm (herramientas y cables)	<b>3</b>	Protegido contra salpicaduras de gotas de agua con una inclinación de 60° respecto a la vertical
<b>4</b>	Protegido contra objetos sólidos de más de 1 mm (herramientas y pequeños cables)	<b>4</b>	Protegido contra salpicaduras de gotas en todas direcciones, el ingreso de cantidades limitadas de agua es permitido
<b>5</b>	Protegido contra ingreso limitado de polvo (no incluye materiales peligrosos)	<b>5</b>	Protegido contra chorros de agua de baja presión, el ingreso limitado de agua es permitido
<b>6</b>	Totalmente protegido contra polvo. Totalmente sellado.	<b>6</b>	Protegido contra potentes chorros de agua
		<b>7</b>	Protegido contra efectos de inmersión temporal
		<b>8</b>	Equipo adecuado para inmersión prolongada bajo las especificaciones de fabricante

¿Qué son las normas NOM?

Las normas mexicanas contienen la información, requisitos, especificaciones y metodologías que deben cumplir los productos o servicios para su comercialización en el país, de acuerdo con sus campos de acción. Su objetivo es adoptar estándares de calidad nacional.



Cumple con las NOM que dicta la ley.

**PRECAUCIÓN**  
NO EXCEDER EL VOLTAJE  
NI AMPERAJE RECOMENDADO



Línea de Placas armadas  
**INOX**

LÍNEA CON ACABADOS  
**PREMIUM**



Línea de Placas  
armadas y modulares

**LUGANO**

LÍNEA QUE RESALTA



Línea de Placas  
armadas y modulares

**STYLE**

GRABADO Y TEXTURA



### INOX1001 - INOX2001

Placa con contacto dúplex



8.5 x 12 cm



● INOX1001 ● INOX2001

MULTIVOLTAJE  
PROTEGE TUS APARATOS

Inner: 10 Master: 100 Incluye: Bolsa Acero inoxidable Polycarbonato Colores disponibles: Plata Oxford

### INOX1024 - INOX2024

Placa con contacto dúplex falla tierra



8.5 x 12 cm



● INOX1024 ● INOX2024

MULTIVOLTAJE  
PROTEGE TUS APARATOS

Inner: 6 Master: 60 Incluye: Bolsa Acero inoxidable Polycarbonato Colores disponibles: Plata Oxford

### INOX1002 - INOX2002

Placa con apagador sencillo y contacto de 1.5 módulos



8.5 x 12 cm



● INOX1002 ● INOX2002

MULTIVOLTAJE  
PROTEGE TUS APARATOS

Inner: 10 Master: 100 Incluye: Bolsa Acero inoxidable Polycarbonato Colores disponibles: Plata Oxford

### INOX1003 - INOX2003

Placa con 1 apagador sencillo y 2 contactos de un módulo



8.5 x 12 cm



● INOX1003 ● INOX2003

MULTIVOLTAJE  
PROTEGE TUS APARATOS

Inner: 10 Master: 100 Incluye: Bolsa Acero inoxidable Polycarbonato Colores disponibles: Plata Oxford

### INOX1004 - INOX2004

Placa con 3 contactos de un módulo



8.5 x 12 cm



● INOX1004 ● INOX2004

MULTIVOLTAJE  
PROTEGE TUS APARATOS

Inner: 10 Master: 100 Incluye: Bolsa Acero inoxidable Polycarbonato Colores disponibles: Plata Oxford

### INOX1005 - INOX2005

Placa con 1 apagador sencillo de 3 módulos



8.5 x 12 cm



● INOX1005 ● INOX2005

MULTIVOLTAJE  
PROTEGE TUS APARATOS

Inner: 10 Master: 100 Incluye: Bolsa Acero inoxidable Polycarbonato Colores disponibles: Plata Oxford



**INOX1006 - INOX2006**

Placa con 2 tomas USB y 1 contacto



8.5 x 12 cm



● INOX1006 ● INOX2006

**MULTIVOLTAJE**  
PROTEGE TUS APARATOS

Inner: 8 Master: 80 Incluye: Bolsa Acero inoxidable Polycarbonato Colores disponibles: Plata Oxford

**INOX1007 - INOX2007**

Placa con 1 apagador escalera y 1 contacto de 1.5 módulos



8.5 x 12 cm



● INOX1007 ● INOX2007

**MULTIVOLTAJE**  
PROTEGE TUS APARATOS

Inner: 10 Master: 100 Incluye: Bolsa Acero inoxidable Polycarbonato Colores disponibles: Plata Oxford

**INOX1008 - INOX2008**

Placa con 1 apagador escalera de 3 módulos



8.5 x 12 cm



● INOX1008 ● INOX2008

**MULTIVOLTAJE**  
PROTEGE TUS APARATOS

Inner: 10 Master: 100 Incluye: Bolsa Acero inoxidable Polycarbonato Colores disponibles: Plata Oxford

**INOX1009 - INOX2009**

Placa con 2 apagadores sencillos y 1 contacto de un módulo



8.5 x 12 cm



● INOX1009 ● INOX2009

**MULTIVOLTAJE**  
PROTEGE TUS APARATOS

Inner: 10 Master: 100 Incluye: Bolsa Acero inoxidable Polycarbonato Colores disponibles: Plata Oxford

**INOX1010 - INOX2010**

Placa con 2 apagadores sencillos de 1.5 módulos



8.5 x 12 cm



● INOX1010 ● INOX2010

**MULTIVOLTAJE**  
PROTEGE TUS APARATOS

Inner: 10 Master: 100 Incluye: Bolsa Acero inoxidable Polycarbonato Colores disponibles: Plata Oxford

**INOX1011 - INOX2011**

Placa con toma coaxial salida T.V.



8.5 x 12 cm



● INOX1011 ● INOX2011

Inner: 10 Master: 100 Incluye: Bolsa Acero inoxidable Polycarbonato Colores disponibles: Plata Oxford

\* Las imágenes mostradas en este catálogo son con fines ilustrativos.  
iGota se reserva el derecho de modificar la información sin previo aviso y no se hace responsable por omisiones o errores en este documento.



### INOX1012 - INOX2012

Placa con 1 apagador sencillo y 1 apagador escalera de 1.5 módulos



8.5 x 12 cm



● INOX1012 ● INOX2012

**MULTIVOLTAJE**  
PROTEGE TUS APARATOS

Inner: Master Incluye Bolsa Acero inoxidable Polycarbonato Colores disponibles: Plata Oxford

### INOX1013 - INOX2013

Placa con 3 apagadores sencillos de un módulo



8.5 x 12 cm



● INOX1013 ● INOX2013

**MULTIVOLTAJE**  
PROTEGE TUS APARATOS

Inner: Master Incluye Bolsa Acero inoxidable Polycarbonato Colores disponibles: Plata Oxford

### INOX1014 - INOX2014

Placa con 2 apagadores escalera de 1.5 módulos



8.5 x 12 cm



● INOX1014 ● INOX2014

**MULTIVOLTAJE**  
PROTEGE TUS APARATOS

Inner: Master Incluye Bolsa Acero inoxidable Polycarbonato Colores disponibles: Plata Oxford

### INOX1015 - INOX2015

Placa ciega



8.5 x 12 cm



● INOX1015 ● INOX2015

Inner: Master Incluye Bolsa Acero inoxidable Polycarbonato Colores disponibles: Plata Oxford

### INOX1016 - INOX2016

Placa con 2 apagadores sencillos y 1 apagador escalera de un módulo



8.5 x 12 cm



● INOX1016 ● INOX2016

**MULTIVOLTAJE**  
PROTEGE TUS APARATOS

Inner: Master Incluye Bolsa Acero inoxidable Polycarbonato Colores disponibles: Plata Oxford

### INOX1017 - INOX2017

Placa con toma telefónica



8.5 x 12 cm



● INOX1017 ● INOX2017

Inner: Master Incluye Bolsa Acero inoxidable Polycarbonato Colores disponibles: Plata Oxford



**INOX1018 - INOX2018**

Placa con 1 botón de timbre



8.5 x 12 cm



**NOM**

● INOX1018 ● INOX2018

**MULTIVOLTAJE**  
PROTEGE TUS APARATOS

Inner: Master Incluye Bolsa Acero Inoxidable Colores disponibles:  
10 100 Polycarbonato ● Plata ● Oxford

**INOX1023 - INOX2023**

Placa con timbre zumbador



8.5 x 12 cm



**NOM**

● INOX1023 ● INOX2023

**MULTIVOLTAJE**  
PROTEGE TUS APARATOS

Inner: Master Incluye Bolsa Acero Inoxidable Colores disponibles:  
10 100 Polycarbonato ● Plata ● Oxford

**INOX1019 - INOX2019**

Placa con dimmer



8.5 x 12 cm



**NOM**

● INOX1019 ● INOX2019

Inner: Master Incluye Bolsa Acero Inoxidable Colores disponibles:  
8 80 Polycarbonato ● Plata ● Oxford

**INOX1020 - INOX2020**

Placa con 1 toma telefónica y 1 toma coaxial salida T.V.



8.5 x 12 cm

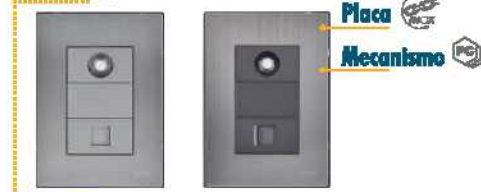

**NOM**

● INOX1020 ● INOX2020

Inner: Master Incluye Bolsa Acero Inoxidable Colores disponibles:  
10 100 Polycarbonato ● Plata ● Oxford

**INOX1021 - INOX2021**

Placa con 3 apagadores escalera de un módulo



8.5 x 12 cm



**NOM**

● INOX1021 ● INOX2021

**MULTIVOLTAJE**  
PROTEGE TUS APARATOS

Inner: Master Incluye Bolsa Acero Inoxidable Colores disponibles:  
10 100 Polycarbonato ● Plata ● Oxford

**INOX1022 - INOX2022**

Placa toma datos



8.5 x 12 cm



**NOM**

● INOX1022 ● INOX2022

Inner: Master Incluye Bolsa Acero Inoxidable Colores disponibles:  
10 100 Polycarbonato ● Plata ● Oxford

\* Las imágenes mostradas en este catálogo son con fines ilustrativos.  
IGota se reserva el derecho de modificar la información sin previo aviso y no se hace responsable por omisiones o errores en este documento.







### PB511 Placa con 1 apagador sencillo de 3 módulos



8x12cm



○ PB511-B



○ PB511-M



● PB511-N

Apagador 125-250 V~/10 A

Policarbonato

**MULTIVOLTAJE**  
PROTEGE TUS APARATOS

Inner  
10

Master  
100

Fácil instalación

Bolsa

Incluye

Colores disponibles:  
○ Blanco ○ Marfil ● Negro

### PB512 Placa con 1 apagador escalera de 3 módulos



8x12cm



○ PB512-B



○ PB512-M



● PB512-N

Apagador 125-250 V~/10 A

Policarbonato

**MULTIVOLTAJE**  
PROTEGE TUS APARATOS

Inner  
10

Master  
100

Fácil instalación

Bolsa

Incluye

Colores disponibles:  
○ Blanco ○ Marfil ● Negro

### PB513 Placa con 2 apagadores sencillos de 1.5 módulos



8x12cm



○ PB513-B



○ PB513-M



● PB513-N

Apagador 125-250 V~/10 A

Policarbonato

**MULTIVOLTAJE**  
PROTEGE TUS APARATOS

Inner  
10

Master  
100

Fácil instalación

Bolsa

Incluye

Colores disponibles:  
○ Blanco ○ Marfil ● Negro

### PB515 Placa con 3 apagadores sencillos de un módulo



8x12cm



○ PB515-B

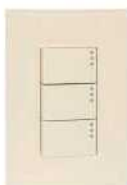

○ PB515-M



● PB515-N

Apagador 125-250 V~/10 A

Polycarbonato

**MULTIVOLTAJE**  
PROTEGE TUS APARATOS

**Inner** 10 **Master** 100 **Fácil instalación** **Bolsa** **Incluye** **Colores disponibles:**  
○ Blanco ○ Marfil ● Negro

### PB612 Placa con apagador sencillo y contacto 2P+T de 1.5 módulos



8x12cm



○ PB612-B



○ PB612-M



● PB612-N

Contacto 125-250 V~/15 A

Apagador 125-250 V~/10 A

Polycarbonato

**MULTIVOLTAJE**  
PROTEGE TUS APARATOS

**Inner** 10 **Master** 100 **Fácil instalación** **Bolsa** **Incluye** **Colores disponibles:**  
○ Blanco ○ Marfil ● Negro

### PB613 Placa con apagador sencillo y apagador escalera de 1.5 módulos



8x12cm



○ PB613-B



○ PB613-M



● PB613-N

Apagador 125-250 V~/10 A

Polycarbonato

**MULTIVOLTAJE**  
PROTEGE TUS APARATOS

**Inner** 10 **Master** 100 **Fácil instalación** **Bolsa** **Incluye** **Colores disponibles:**  
○ Blanco ○ Marfil ● Negro





### PB615 Placa con 2 apagadores sencillos y apagador escalera de 1 módulo



8x12cm



○ PB615-B



○ PB615-M



● PB615-N

Apagador 125-250 V~/10 A

Policarbonato

**MULTIVOLTAJE**  
PROTEGE TUS APARATOS

Inner  
10

Master  
100

Fácil instalación



Bolsa



Incluye



Colores disponibles:

○ Blanco ○ Marfil ● Negro

### PB414 Placa con 1 apagador sencillo y 2 contactos 2P+T



8x12cm



○ PB414-B

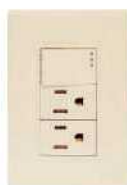

○ PB414-M



● PB414-N

Apagador 125-250 V~/10 A

Contacto 125-250 V~/15 A

Policarbonato

**MULTIVOLTAJE**  
PROTEGE TUS APARATOS

Inner  
10

Master  
100

Fácil instalación



Bolsa



Incluye



Colores disponibles:

○ Blanco ○ Marfil ● Negro

### PB412 Placa con 2 apagadores sencillo y 1 contacto 2P+T



8x12cm



○ PB412-B

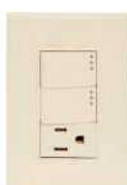

○ PB412-M



● PB412-N

Apagador 125-250 V~/10 A

Contacto 125-250 V~/15 A

Policarbonato

**MULTIVOLTAJE**  
PROTEGE TUS APARATOS

Inner  
10

Master  
100

Fácil instalación



Bolsa



Incluye



Colores disponibles:

○ Blanco ○ Marfil ● Negro



### PB105/3 Placa con 3 contactos 2P+T de un módulo



8x12cm



○ PB105/3-B



○ PB105/3-M



● PB105/3-N

Contacto 125-250 V~/15 A

Policarbonato

**MULTIVOLTAJE**  
PROTEGE TUS APARATOS

**Inner** 10 **Master** 100 **Fácil Instalación** **Bolsa** **Incluye** **Colores disponibles:**  
○ Blanco ○ Marfil ● Negro

### PBUSB2 Placa con 2 USB y 2 contactos de un módulo



8x12cm



○ PBUSB2-B



○ PBUSB2-M



● PBUSB2-N

Contacto 125-250 V~/15 A

In Put 110-250 V~ Out Put 5 V~-2.1 A Frecuencia 50/60 Hz

Policarbonato

**MULTIVOLTAJE**  
PROTEGE TUS APARATOS

**Inner** 8 **Master** 80 **Fácil Instalación** **Bolsa** **Incluye** **Colores disponibles:**  
○ Blanco ○ Marfil ● Negro

### PBUSB4 Placa con 4 USB y 1 contacto de un módulo



8x12cm



○ PBUSB4-B



○ PBUSB4-M



● PBUSB4-N

Contacto 125-250 V~/15 A

In Put 110-250 V~ Out Put 5 V~-2.1 A Frecuencia 50/60 Hz

Policarbonato

**MULTIVOLTAJE**  
PROTEGE TUS APARATOS

**Inner** 8 **Master** 80 **Fácil Instalación** **Bolsa** **Incluye** **Colores disponibles:**  
○ Blanco ○ Marfil ● Negro



### PB106UL Placa con contacto USB doble



8x12cm



○ PB106UL-B



○ PB106UL-M



● PB106UL-N

In Put 110-250 V~ Out Put 5 V~-2.1 A Frecuencia 50/60 Hz

Contacto 125-250 V~/15 A

Polycarbonato

MULTIVOLTAJE  
PROTEGE TUS APARATOS

Inner 8

Master 80

Fácil instalación

Bolsa

Incluye

Colores disponibles:

○ Blanco ○ Marfil ● Negro

### PB519 Placa con botón timbre



8x12cm



○ PB519-B



○ PB519-M



● PB519-N

125-250 V~

Polycarbonato

MULTIVOLTAJE  
PROTEGE TUS APARATOS

Inner 10

Master 100

Fácil instalación

Bolsa

Incluye

Colores disponibles:

○ Blanco ○ Marfil ● Negro

### PB402 Placa con toma de teléfono



8x12cm



○ PB402-B



○ PB402-M



● PB402-N

Polycarbonato

Inner 10

Master 100

Fácil instalación

Bolsa

Incluye

Colores disponibles:

○ Blanco ○ Marfil ● Negro

### PB302 Placa con toma coaxial TV



8x12cm



○ PB302-B



○ PB302-M



● PB302-N

**Policarbonato**

**Inner** 10 **Master** 100 **Fácil instalación** **Bolsa** **Incluye** **Colores disponibles:**  
 ○ Blanco ○ Marfil ● Negro

### PB201 Placa con dimmer



8x12cm



○ PB201-B



○ PB201-M



● PB201-N

200 W

**Policarbonato**

**Inner** 6 **Master** 60 **Fácil instalación** **Bolsa** **Incluye** **Colores disponibles:**  
 ○ Blanco ○ Marfil ● Negro

### PB105/2 Contacto dúplex con placa



8x12cm



○ PB105/2-B



○ PB105/2-M



● PB105/2-B

**Contacto** 125-250 V~/15 A

**Policarbonato**

**MULTIVOLTAJE**  
 PROTEGE TUS APARATOS

**Inner** 10 **Master** 100 **Fácil instalación** **Bolsa** **Incluye** **Colores disponibles:**  
 ○ Blanco ○ Marfil ● Negro



### PB801 Contacto dúplex falla tierra con placa

NUEVO



8x12cm



○ PB801-B



○ PB801-M



● PB801-B

Contacto 125-250 V~/15 A

Polycarbonato

MULTIVOLTAJE  
PROTEGE TUS ARMATOS

Inner  
10

Master  
100

Fácil instalación



Bolsa



Incluye



Colores disponibles:

○ Blanco ○ Marfil ● Negro

### PB105/2 Contacto dúplex con placa



8x12cm



○ PB105/2-A/B



● PB105/2-A/N



○ PB105/2-B/N



● PB105/2-N/B

Contacto 125-250 V~/15 A

Polycarbonato

MULTIVOLTAJE  
PROTEGE TUS ARMATOS

Inner  
10

Master  
100

Fácil instalación



Bolsa



Incluye



Colores disponibles:

○ Plata-Blanco ● Plata-Negro  
● Negro-Blanco ○ Blanco-Negro

### PB105/2-D Contacto dúplex con placa



8x12cm



○ PB105/2-D/B



○ PB105/2-D/M



○ PB105/2-D/N

Contacto 125-250 V~/15 A

Polycarbonato

MULTIVOLTAJE  
PROTEGE TUS ARMATOS

Inner  
10

Master  
100

Fácil instalación



Bolsa



Incluye



Colores disponibles:

○ Dorado-Blanco ○ Dorado-Marfil  
● Dorado-Negro

### PB105/2-MC Contacto dúplex con placa



8x12cm



● PB105/2-MC/B



● PB105/2-MC/M



● PB105/2-MC/N

Contacto 125-250 V~/15 A

Polycarbonato

**MULTIVOLTAJE**  
PROTEGE TUS APARATOS

Inner  
10

Master  
100

Fácil instalación

Bolsa

Incluye

Colores disponibles:

- Caoba-Blanco
- Caoba-Marfil
- Caoba-Negro

### PB105/2-MW Contacto dúplex con placa



8x12cm



● PB105/2-MW/B



● PB105/2-MW/M



● PB105/2-MW/N

Contacto 125-250 V~/15 A

Polycarbonato

**MULTIVOLTAJE**  
PROTEGE TUS APARATOS

Inner  
10

Master  
100

Fácil instalación

Bolsa

Incluye

Colores disponibles:

- Wenge-Blanco
- Wenge-Marfil
- Wenga-Negro

### PB1201 Placa con 1 módulo



8x12cm



○ PB1201-B



○ PB1201-M



○ PB1201-PE



○ PB1201-D



○ PB1201-P



● PB1201-GR



● PB1201-N



● PB1201-MW



● PB1201-MC

Inner  
20

Master  
200

Fácil instalación

Bolsa

Incluye

Colores disponibles:

- Blanco
- Marfil
- Perla
- Dorado
- Plata
- Grafito
- Negro
- Wenge
- Caoba

\* Las imágenes mostradas en este catálogo son con fines ilustrativos. IGota se reserva el derecho de modificar la información sin previo aviso y no se hace responsable por omisiones o errores en este documento.



### PB1202 Placa con 2 módulos



8x12cm



○ PB1202-B ○ PB1202-M ○ PB1202-PE ○ PB1202-D ○ PB1202-P ● PB1202-GR ● PB1202-N ● PB1202-MW ● PB1202-MC

Inner  
20

Master  
200

Fácil instalación 

Bolsa 

Incluye 

Colores disponibles:

○ Blanca ○ Marfil ○ Perla ○ Dorado ○ Plata ● Grafito  
● Negro ● Wenge ● Caoba

### PB1203 Placa con 3 módulos



8x12cm



○ PB1203-B ○ PB1203-M ○ PB1203-PE ○ PB1203-D ○ PB1203-P ● PB1203-GR ● PB1203-N ● PB1203-MW ● PB1203-MC

Inner  
20

Master  
200

Fácil instalación 

Bolsa 

Incluye 

Colores disponibles:

○ Blanca ○ Marfil ○ Perla ○ Dorado ○ Plata ● Grafito  
● Negro ● Wenge ● Caoba

### PB1200 Placa ciega



8x12cm



○ PB1200-B ○ PB1200-M ○ PB1200-PE ○ PB1200-D ○ PB1200-P ● PB1200-GR ● PB1200-N ● PB1200-MW ● PB1200-MC

Inner  
20

Master  
200

Fácil instalación 

Bolsa 

Incluye 

Colores disponibles:

○ Blanca ○ Marfil ○ Perla ○ Dorado ○ Plata ● Grafito  
● Negro ● Wenge ● Caoba



### PS511 Placa con 1 apagador sencillo de 3 módulos

8x12cm



PS511-B  PS511-M  PS511-PE  PS511-GR

**MULTIVOLTAJE**  
PROTEGE TUS APARATOS

**Inner** 10 **Master** 100 **Fácil instalación** **Bolsa** **Incluye** **Colores disponibles:**  
 Blanco  Marfil  Perla  Grafito



### PS512 Placa con 1 apagador escalera de 3 módulos

8x12cm



PS512-B  PS512-M  PS512-PE  PS512-GR

**MULTIVOLTAJE**  
PROTEGE TUS APARATOS

**Inner** 10 **Master** 100 **Fácil instalación** **Bolsa** **Incluye** **Colores disponibles:**  
 Blanco  Marfil  Perla  Grafito



### PS613 Placa con apagador sencillo y apagador escalera de 1.5 módulos

8x12cm



PS613-B  PS613-M  PS613-PE  PS613-GR

**MULTIVOLTAJE**  
PROTEGE TUS APARATOS

**Inner** 10 **Master** 100 **Fácil instalación** **Bolsa** **Incluye** **Colores disponibles:**  
 Blanco  Marfil  Perla  Grafito





## PS612 Placa con apagador sencillo y contacto 2P+T de 1.5 módulos



8x12cm

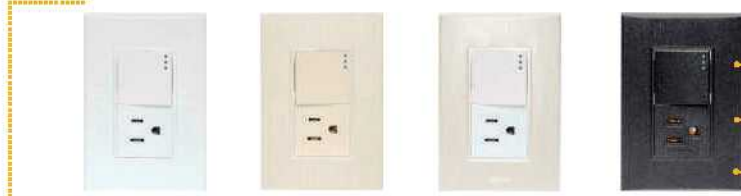

Apagador 125-250 V~/10 A

Contacto 125-250 V~/15 A

Policarbonato

○ PS612-B    ○ PS612-M    ○ PS612-PE    ● PS612-GR

**MULTIVOLTAJE**  
PROTEGE TUS APARATOS

**Inner** 10    **Master** 100    **Fácil instalación**    **Bolsa**    **Incluye**    **Colores disponibles:**  
○ Blanco    ○ Marfil    ○ Perla    ● Grafito

## PS513 Placa con 2 apagadores sencillos de 1.5 módulos



8x12cm

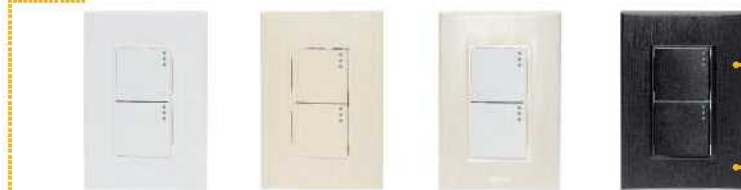

Apagador 125-250 V~/10 A

Policarbonato

○ PS513-B    ○ PS513-M    ○ PS513-PE    ● PS513-GR

**MULTIVOLTAJE**  
PROTEGE TUS APARATOS

**Inner** 10    **Master** 100    **Fácil instalación**    **Bolsa**    **Incluye**    **Colores disponibles:**  
○ Blanco    ○ Marfil    ○ Perla    ● Grafito

## PS515 Placa con 3 apagadores sencillos de 1 módulo



8x12cm

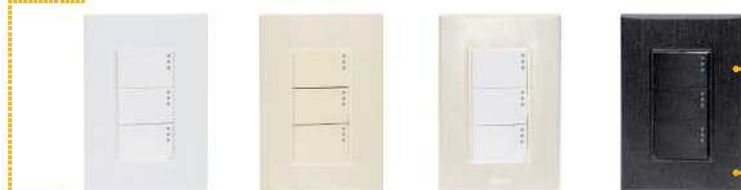

Apagador 125-250 V~/10 A

Policarbonato

○ PS515-B    ○ PS515-M    ○ PS515-PE    ● PS515-GR

**MULTIVOLTAJE**  
PROTEGE TUS APARATOS

**Inner** 10    **Master** 100    **Fácil instalación**    **Bolsa**    **Incluye**    **Colores disponibles:**  
○ Blanco    ○ Marfil    ○ Perla    ● Grafito

### PS414 Placa con 1 apagador sencillo y 2 contactos 2PT+T de un módulo



8x12cm



○ PS414-B   ○ PS414-M   ○ PS414-PE   ● PS414-GR

**MULTIVOLTAJE**  
PROTEGE TUS APARATOS

**Inner** 10   **Master** 100   **Fácil instalación**   **Bolsa**   **Incluye**   **Colores disponibles:**  
○ Blanco   ○ Marfil   ○ Perla   ● Grafito

### PS615 Placa con 2 apagadores sencillos y uno de escalera de un módulo



8x12cm



○ PS615-B   ○ PS615-M   ○ PS615-PE   ● PS615-GR

**MULTIVOLTAJE**  
PROTEGE TUS APARATOS

**Inner** 10   **Master** 100   **Fácil instalación**   **Bolsa**   **Incluye**   **Colores disponibles:**  
○ Blanco   ○ Marfil   ○ Perla   ● Grafito

### PS412 Placa con 2 apagadores sencillos y contacto 2P+T de 1 módulo



8x12cm



○ PS412-B   ○ PS412-M   ○ PS412-PE   ● PS412-GR

**MULTIVOLTAJE**  
PROTEGE TUS APARATOS

**Inner** 10   **Master** 100   **Fácil instalación**   **Bolsa**   **Incluye**   **Colores disponibles:**  
○ Blanco   ○ Marfil   ○ Perla   ● Grafito





### PS105/2 Contacto dúplex con placa



8x12cm



○ PS105/2-B ○ PS105/2-M ○ PS105/2-PE ● PS105/2-GR

**MULTIVOLTAJE**  
PROTEGE TUS APARATOS

**Inner** 10 **Master** 100 **Fácil instalación**  **Bolsa**  **Incluye**  **Colores disponibles:**  
○ Blanco ○ Marfil ○ Perla ● Grafito

### PS801 Contacto dúplex con placa falla tierra

**NUEVO**



8x12cm



○ PS801-B ○ PS801-M ○ PS801-PE ● PS801-GR

**MULTIVOLTAJE**  
PROTEGE TUS APARATOS

**Inner** 6 **Master** 60 **Fácil instalación**  **Bolsa**  **Incluye**  **Colores disponibles:**  
○ Blanco ○ Marfil ○ Perla ● Grafito

### PS105/3 Placa con 3 contactos 2P+T de un módulo



8x12cm



○ PS105/3-B ○ PS105/3-M ○ PS105/3-PE ● PS105/3-GR

**MULTIVOLTAJE**  
PROTEGE TUS APARATOS

**Inner** 10 **Master** 100 **Fácil instalación**  **Bolsa**  **Incluye**  **Colores disponibles:**  
○ Blanco ○ Marfil ○ Perla ● Grafito

### PS519 Placa con botón timbre

8x12cm



○ PS519-B   ○ PS519-M   ○ PS519-PE   ● PS519-GR

125-250 V~  
Policarbonato

**MULTIVOLTAJE**  
PROTEGE TUS APARATOS



**Inner** 10   **Master** 100   **Fácil instalación**   **Bolsa**   **Incluye**   **Colores disponibles:**  
○ Blanco   ○ Marfil   ○ Perla   ● Grafito

### PSUSB2 Placa con 2 USB y 2 contactos de un módulo

8x12cm



○ PSUSB2-B   ○ PSUSB2-M   ○ PSUSB2-PE   ● PSUSB2-GR

**In Put** 110-250 V~   **Out Put** 5 V~ -2.1 A   **Frecuencia** 50/60 Hz  
**Contacto** 125-250 V~/15 A  
Policarbonato

**MULTIVOLTAJE**  
PROTEGE TUS APARATOS



**Inner** 8   **Master** 80   **Fácil instalación**   **Bolsa**   **Incluye**   **Colores disponibles:**  
○ Blanco   ○ Marfil   ○ Perla   ● Grafito

### PSUSB4 Placa con 4 USB y 1 contacto de un módulo

8x12cm



○ PSUSB4-B   ○ PSUSB4-M   ○ PSUSB4-PE   ● PSUSB4-GR

**In Put** 110-250 V~   **Out Put** 5 V~ -2.1 A   **Frecuencia** 50/60 Hz  
**Contacto** 125-250 V~/15 A  
Policarbonato

**MULTIVOLTAJE**  
PROTEGE TUS APARATOS



**Inner** 8   **Master** 80   **Fácil instalación**   **Bolsa**   **Incluye**   **Colores disponibles:**  
○ Blanco   ○ Marfil   ○ Perla   ● Grafito

\* Las imágenes mostradas en este catálogo son con fines ilustrativos.  
IGoto se reserva el derecho de modificar la información sin previo aviso y no se hace responsable por omisiones o errores en este documento.



## PS106UL Placa con contacto USB doble



8x12cm

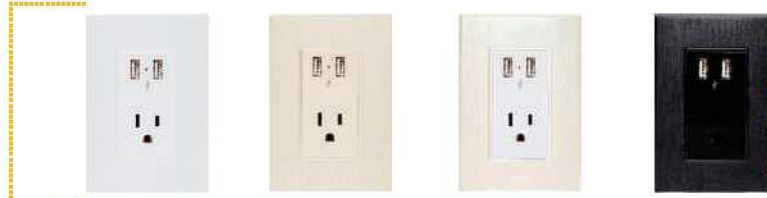

**In Put** 110-250 V~ | **Out Put** 5 V~ -2.1 A | **Frecuencia** 50/60 Hz

**Contacto** 125-250 V~/15 A

**Polycarbonato**

○ PS106UL-B ○ PS106UL-M ○ PS106UL-PE ● PS106UL-GR

**MULTIVOLTAJE**  
PROTEGE TUS APARATOS

**Inner** 8 **Master** 80 **Fácil instalación** **Bolsa** **Incluye** **Colores disponibles:**  
○ Blanco ○ Marfil ○ Perla ● Grafito

## PS201 Placa con dimmer



8x12cm

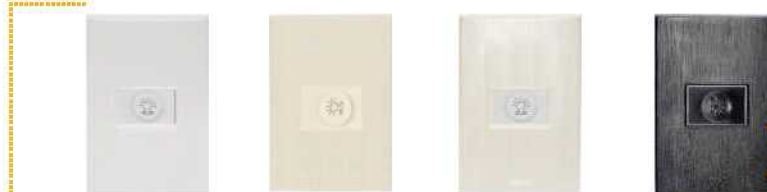

200 W

**Polycarbonato**

○ PS201-B ○ PS201-M ○ PS201-PE ● PS201-GR

**MULTIVOLTAJE**  
PROTEGE TUS APARATOS

**Inner** 8 **Master** 80 **Fácil instalación** **Bolsa** **Incluye** **Colores disponibles:**  
○ Blanco ○ Marfil ○ Perla ● Grafito

## PS302 Placa con toma coaxial



8x12cm



**Polycarbonato**

○ PS302-B ○ PS302-M ○ PS302-PE ● PS302-GR

**MULTIVOLTAJE**  
PROTEGE TUS APARATOS

**Inner** 10 **Master** 100 **Fácil instalación** **Bolsa** **Incluye** **Colores disponibles:**  
○ Blanco ○ Marfil ○ Perla ● Grafito





### PS402 Placa con toma de teléfono



8x12cm



- PS402-B
- PS402-M
- PS402-PE
- PS402-GR

**MULTIVOLTAJE**  
PROTEGE TUS APARATOS

**Inner** 10 **Master** 100 **Fácil instalación** **Bolsa** **Incluye** **Colores disponibles:**  
 Blanco  Marfil  Perla  Grafito

### PS1201 Placa con 1 módulo



8x12cm



- PS1201-B
- PS1201-M
- PS1201-PE
- PS1201-D
- PS1201-P
- PS1201-GR
- PS1201-N

**Inner** 20 **Master** 200 **Fácil instalación** **Bolsa** **Incluye** **Colores disponibles:**  
 Blanco  Marfil  Dorado  Grafito  
 Negro  Perla  Plata

### PS1202 Placa con 2 módulos



8x12cm



- PS1202-B
- PS1202-M
- PS1202-PE
- PS1202-D
- PS1202-P
- PS1202-GR
- PS1202-N

**Inner** 20 **Master** 200 **Fácil instalación** **Bolsa** **Incluye** **Colores disponibles:**  
 Blanco  Marfil  Dorado  Grafito  
 Negro  Perla  Plata

\* Las imágenes mostradas en este catálogo son con fines ilustrativos.  
 ¡Gota se reserva el derecho de modificar la información sin previo aviso y no se hace responsable por omisiones o errores en este documento.



## PS1203 Placa con 3 módulos



NOM

8x12 cm



Polycarbonato

- PS1203-B
- PS1203-M
- PS1203-PE
- PS1203-D
- PS1203-P
- PS1203-GR
- PS1203-N

<b>Inner</b>	<b>Master</b>	<b>Fácil instalación</b>	<b>Bolsa</b>	<b>Incluye</b>	<b>Colores disponibles:</b>
20	200				<ul style="list-style-type: none"> <li>○ Blanco</li> <li>○ Marfil</li> <li>○ Dorado</li> <li>● Negro</li> <li>○ Perla</li> <li>○ Plata</li> <li>● Grafita</li> </ul>

## PS1200 Placa ciega



NOM

8x12 cm



Polycarbonato

- PS1200-B
- PS1200-M
- PS1200-PE
- PS1200-D
- PS1200-P
- PS1200-GR
- PS1200-N

<b>Inner</b>	<b>Master</b>	<b>Fácil instalación</b>	<b>Bolsa</b>	<b>Incluye</b>	<b>Colores disponibles:</b>
20	200				<ul style="list-style-type: none"> <li>○ Blanco</li> <li>○ Marfil</li> <li>○ Dorado</li> <li>● Negro</li> <li>○ Perla</li> <li>○ Plata</li> <li>● Grafita</li> </ul>

## DIAGRAMAS DE MONTAJE

UN MÓDULO

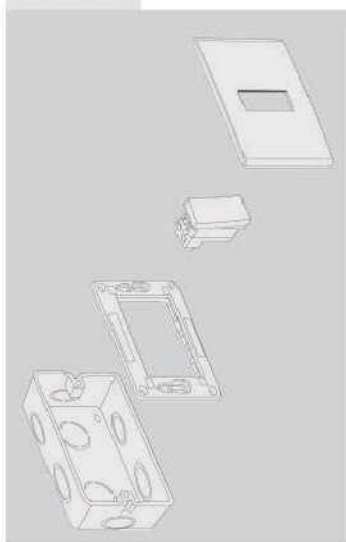

DOS MÓDULOS

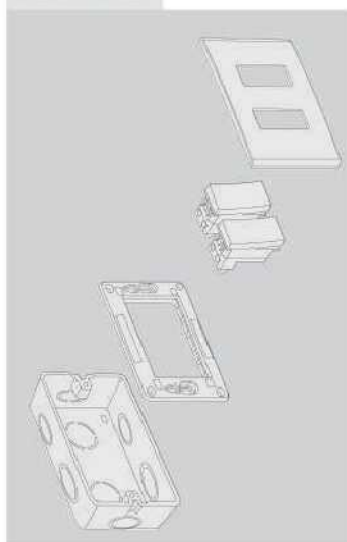

TRES MÓDULOS

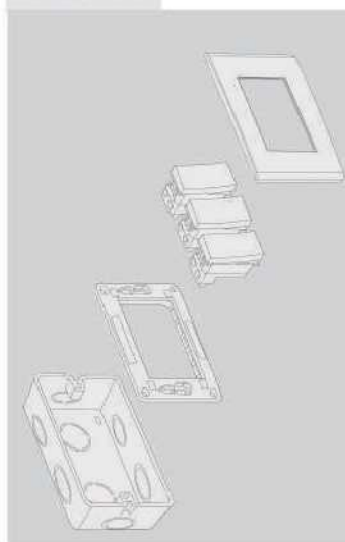

UN MÓDULO

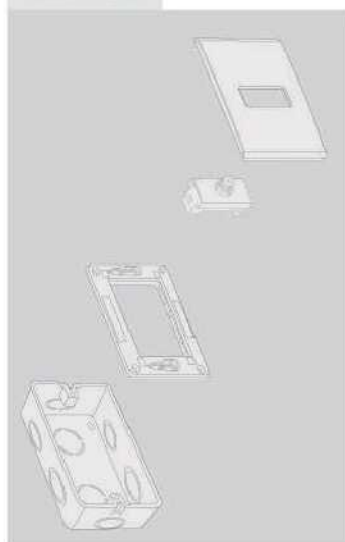

### PA1000 Marcos de color Zurich

Imágenes montadas en placas para fines ilustrativos. No incluye placa

Todos los marcos son compatibles con la línea ZURICH PLUS los modelos PA1201, PA1202 y PA1203.



NOM

8x12cm



- PA1000-R
- PA1000-A
- PA1000-NA
- PA1000-N
- PA1000-CA
- PA1000-C

**Inner** 40 **Master** 400 **Fácil instalación** **Bolsa** **Incluye**

**Colores disponibles:**  
○ Blanco ● Rojo ● Azul ● Naranja  
● Negro ● Café ● Cromo

Policarbonato

### PA105 Contacto duplex con placa



NOM

8x12cm



- PA105/2-B
- PA105/2-BC
- PA105/2-BN
- PA105/2-B/N
- PA105/2-M
- PA105/2-MCA

**Inner** 10 **Master** 100 **Fácil instalación** **Bolsa** **Incluye**

**Colores disponibles:**  
○ Blanco ● Blanco-Cromo ● Negro-Blanco ○ Blanco-Negro ○ Marfil  
● Café-Marfil

Contacto 125-250 V~/15 A

Policarbonato

MULTIVOLTAJE  
PROTEGE TUS APARATOS

### PA1201 Placa con 1 módulo con marco de color



NOM

8x12cm

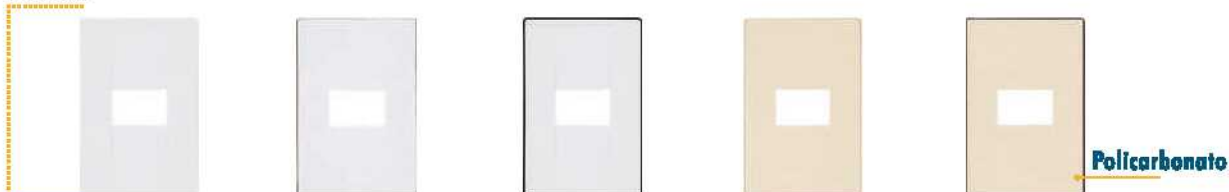

- PA1201-B
- PA1201-BC
- PA1201-BN
- PA1201-M
- PA1201-MCA

**Inner** 20 **Master** 200 **Fácil instalación** **Bolsa** **Incluye**

**Colores disponibles:**  
○ Blanco ● Blanco-Cromo ● Blanco-Negro ○ Marfil ● Marfil-Café

Policarbonato

\* Las imágenes mostradas en este catálogo son con fines ilustrativos. IGoto se reserva el derecho de modificar la información sin previo aviso y no se hace responsable por omisiones o errores en este documento.







### PA1202 Placa con 2 módulos con marco de color



8x12cm

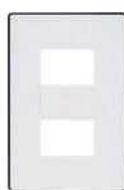

Policarbonato

PA1202-B

PA1202-BC

PA1202-BN

PA1202-M

PA1202-MCA

Inner 20 Master 200

Fácil instalación

Bolsa

Incluye

Colores disponibles:

Blanco  Blanco-Cromo  Blanco-Negro  
 Marfil  Marfil-Café

### PA1203 Placa con 3 módulos con marco de color



8x12cm

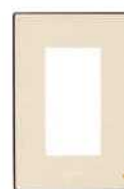
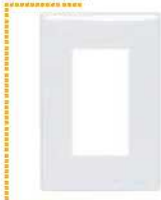

Policarbonato

PA1203-B

PA1203-BC

PA1203-BN

PA1203-M

PA1203-MCA

Inner 20 Master 200

Fácil instalación

Bolsa

Incluye

Colores disponibles:

Blanco  Blanco-Cromo  Blanco-Negro  
 Marfil  Marfil-Café

### PA1200 Placa ciega con marco de color



8x12cm



Policarbonato

PA1200-B

PA1200-BC

PA1200-BN

PA1200-M

PA1200-MCA

Inner 20 Master 200

Fácil instalación

Bolsa

Incluye

Colores disponibles:

Blanco  Blanco-Cromo  Blanco-Negro  
 Marfil  Marfil-Café



## PA590 Sensor de movimiento

8 x 12 cm

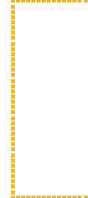

○ PA590-B



● PA590-M



● PA590-N



**Polycarbonato**

**Inner** 8 **Master** 80 **Fácil instalación** **Bolsa** **Incluye** **Colores disponibles:**  
 ○ Blanco ● Marfil ● Negro

## DIAGRAMAS DE MONTAJE

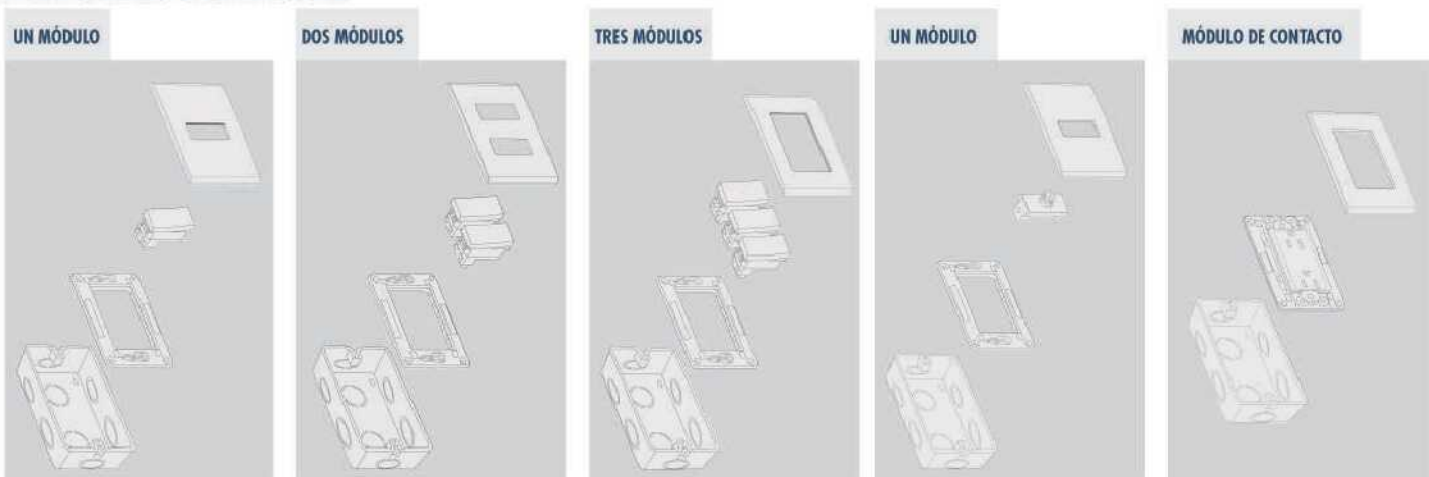

COMPATIBLE CON LÍNEA DE PLACAS: **LP** LUGANO PLUS **SP** STYLE PLUS **ZP** ZURICH PLUS

**MECANISMOS** ➤

## D2087 Apagador de tarjeta



125~/30 A

**Polycarbonato**



○ D2087-B

Incluye tarjeta

**Inner** 8 **Master** 80 **Bolsa** **Colores disponibles:**  
 ○ Blanco

## B1513 Módulo de contacto dúplex universal



○ B1513-B



● B1513-M



● B1513-N

125~/15 A

**Polycarbonato**



**MULTIVOLTAJE**  
 PROTEGE TUS APARATOS

**Inner** 6 **Master** 144 **Bolsa** **Colores disponibles:**  
 ● Marfil ○ Blanco ● Negro  
**Compatible con:** **ZP** **LP** **SP**

\* Las imágenes mostradas en este catálogo son con fines ilustrativos. IGoto se reserva el derecho de modificar la información sin previo aviso y no se hace responsable por omisiones o errores en este documento.



### B5151 Apagador sencillo 3 módulos



○ B5151-B



○ B5151-M



● B5151-N

Apagador 125-250 V~/10 A

Polycarbonato

**MULTIVOLTAJE**  
PROTEGE TUS APARATOS

**Inner** 6 **Master** 144 **Fijado por presión** **Bolsa** **Compatible con:** **Colores disponibles:** ○ Blanco ○ Marfil ● Negro

### B5152 Apagador escalera 3 módulos



○ B5152-B



○ B5152-M



● B5152-N

Apagador 125-250 V~/10 A

Polycarbonato

**MULTIVOLTAJE**  
PROTEGE TUS APARATOS

**Inner** 6 **Master** 144 **Fijado por presión** **Bolsa** **Compatible con:** **Colores disponibles:** ○ Blanco ○ Marfil ● Negro

### BN5151 Apagador 3 módulos con luz piloto



○ BN5151-B



○ BN5151-M



● BN5151-N

Apagador 125-250 V~/10 A

Polycarbonato

**MULTIVOLTAJE**  
PROTEGE TUS APARATOS

**Inner** 6 **Master** 144 **Fijado por presión** **Bolsa** **Compatible con:** **Colores disponibles:** ○ Blanco ○ Marfil ● Negro





### BN5152 Apagador escalera con luz piloto 3 módulos



○ BN5152-B



○ BN5152-M



● BN5152-N

Apagador 125-250 V~/10 A

Polycarbonato

**MULTIVOLTAJE**  
PROTEGE TUS APARATOS

<b>Inner</b>	<b>Master</b>	<b>Fijado por presión</b>	<b>Bolsa</b>	<b>Compatible con:</b>	<b>Colores disponibles:</b>
6	144				○ Blanco ○ Marfil ● Negro

### B5251 Apagador sencillo 1.5 módulos



○ B5251-B



○ B5251-M



● B5251-N

Apagador 125-250 V~/10 A

Polycarbonato

**MULTIVOLTAJE**  
PROTEGE TUS APARATOS

<b>Inner</b>	<b>Master</b>	<b>Fijado por presión</b>	<b>Bolsa</b>	<b>Compatible con:</b>	<b>Colores disponibles:</b>
12	288				○ Blanco ○ Marfil ● Negro

### B5252 Apagador escalera 1.5 módulos



○ B5252-B



○ B5252-M



● B5252-N

Apagador 125-250 V~/10 A

Polycarbonato

**MULTIVOLTAJE**  
PROTEGE TUS APARATOS

<b>Inner</b>	<b>Master</b>	<b>Fijado por presión</b>	<b>Bolsa</b>	<b>Compatible con:</b>	<b>Colores disponibles:</b>
12	288				○ Blanco ○ Marfil ● Negro

\* Las imágenes mostradas en este catálogo son con fines ilustrativos. IGoto se reserva el derecho de modificar la información sin previo aviso y no se hace responsable por omisiones o errores en este documento.





### BN5251 Apagador 1.5 módulos con luz piloto



○ BN5251-B



○ BN5251-M



● BN5251-N

Apagador 125-250 V~/10 A

Policarbonato

**MULTIVOLTAJE**  
PROTEGE TUS APARATOS

**Inner** 12 **Master** 288 **Fijado por presión** **Bolsa** **Compatible con:** **ZP** **LP** **SP** **Colores disponibles:** ○ Blanco ○ Marfil ● Negro

### BN5252 Apagador escalera 1.5 módulos con luz piloto



○ BN5252-B



○ BN5252-M



● BN5252-N

Apagador 125-250 V~/10 A

Policarbonato

**MULTIVOLTAJE**  
PROTEGE TUS APARATOS

**Inner** 12 **Master** 288 **Fijado por presión** **Bolsa** **Compatible con:** **ZP** **LP** **SP** **Colores disponibles:** ○ Blanco ○ Marfil ● Negro

### B5451 Apagador doble de 1.5 módulos sencillos



○ B5451-B



○ B5451-M



● B5451-N

Apagador 125-250 V~/10 A

Policarbonato

**MULTIVOLTAJE**  
PROTEGE TUS APARATOS

**Inner** 12 **Master** 288 **Fijado por presión** **Bolsa** **Compatible con:** **ZP** **LP** **SP** **Colores disponibles:** ○ Blanco ○ Marfil ● Negro

### B5452 Apagador doble de 1.5 módulos escalera



Apagador 125-250 V~/10 A

Policarbonato

○ B5452-B

○ B5452-M

● B5452-N

**MULTIVOLTAJE**  
PROTEGE TUS APARATOS

<b>Inner</b> 12	<b>Master</b> 288	<b>Fijado por presión</b> 	<b>Bolsa</b> 	<b>Compatible con:</b> ZP LP SP	<b>Colores disponibles:</b> ○ Blanco ○ Marfil ● Negro
--------------------	----------------------	-------------------------------	------------------	------------------------------------	--

### B5351 Apagador sencillo de 1 módulo



Apagador 125-250 V~/10 A

Policarbonato

○ B5351-B

○ B5351-M

● B5351-N

**MULTIVOLTAJE**  
PROTEGE TUS APARATOS

<b>Inner</b> 18	<b>Master</b> 432	<b>Fijado por presión</b> 	<b>Bolsa</b> 	<b>Compatible con:</b> ZP LP SP	<b>Colores disponibles:</b> ○ Blanco ○ Marfil ● Negro
--------------------	----------------------	-------------------------------	------------------	------------------------------------	--

### B5352 Apagador escalera 1 módulo



Apagador 125-250 V~/10 A

Policarbonato

○ B5352-B

○ B5352-M

● B5352-N

**MULTIVOLTAJE**  
PROTEGE TUS APARATOS

<b>Inner</b> 18	<b>Master</b> 432	<b>Fijado por presión</b> 	<b>Bolsa</b> 	<b>Compatible con:</b> ZP LP SP	<b>Colores disponibles:</b> ○ Blanco ○ Marfil ● Negro
--------------------	----------------------	-------------------------------	------------------	------------------------------------	--





### BN5351 Apagador 1 módulo con luz piloto



Apagador 125-250 V~/10 A

Polycarbonato

BN5351-B

BN5351-M

BN5351-N

**MULTIVOLTAJE**  
PROTEGE TUS APARATOS

**Inner** 12 **Master** 288 **Fijado por presión**  **Bolsa**  **Compatible con:**  ZP  LP  SP **Colores disponibles:**  Blanco  Marfil  Negro

### BN5352 Apagador escalera 1 módulo con luz piloto



Apagador 125-250 V~/10 A

Polycarbonato

BN5352-B

BN5352-M

BN5352-N

**MULTIVOLTAJE**  
PROTEGE TUS APARATOS

**Inner** 18 **Master** 432 **Fijado por presión**  **Bolsa**  **Compatible con:**  ZP  LP  SP **Colores disponibles:**  Blanco  Marfil  Negro

### B5332 Apagador 1 módulo de 4 vías



Apagador 125-250 V~/10 A

Polycarbonato

B5332-B

B5332-M

B5332-N

**MULTIVOLTAJE**  
PROTEGE TUS APARATOS

**Inner** 18 **Master** 432 **Fijado por presión**  **Bolsa**  **Compatible con:**  ZP  LP  SP **Colores disponibles:**  Blanco  Marfil  Negro

### B2101 Contacto 1 módulo 2P+T



Contacto 125-250 V~/15 A

Policarbonato

○ B2101-B

● B2101-M

● B2101-N

**MULTIVOLTAJE**  
PROTEGE TUS APARATOS

Inner  
18

Master  
432

Fijado por presión



Bolsa



Compatible con:



Colores disponibles:

○ Blanco ● Marfil ● Negro

### B3101 Contacto 1.5 módulos 2P+T



Contacto 125-250 V~/15 A

Policarbonato

○ B3101-B

● B3101-M

● B3101-N

**MULTIVOLTAJE**  
PROTEGE TUS APARATOS

Inner  
12

Master  
288

Fijado por presión



Bolsa



Compatible con:



Colores disponibles:

○ Blanco ● Marfil ● Negro

### B1512 Módulo de contacto dúplex

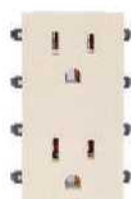

Contacto 125-250 V~/15 A

Policarbonato

○ B1512-B

● B1512-M

● B1512-N

**MULTIVOLTAJE**  
PROTEGE TUS APARATOS

Inner  
6

Master  
144

Fijado por presión



Bolsa



Compatible con:



Colores disponibles:

○ Blanco ● Marfil ● Negro



### BUSB Toma conexión USB



**In Put** 110-250 V~ | **Out Put** 5 V~ -2.1 A | **Frecuencia** 50/60 Hz

**Polycarbonato**

**BUSB-B**

**BUSB-M**

**BUSB-N**

**MULTIVOLTAJE**  
PROTEGE TUS APARATOS

**Inner**  
18

**Master**  
432

**Fijado por presión**

**Bolsa**

**Compatible con:**  
 ZP  LP  SP

**Colores disponibles:**  
 Blanco  Marfil  Negro

### 2USB Toma doble conexión USB



**In Put** 110-250 V~ | **Out Put** 5 V~ -2.1 A | **Frecuencia** 50/60 Hz

**Polycarbonato**

**2USB-B**

**2USB-M**

**2USB-N**

**MULTIVOLTAJE**  
PROTEGE TUS APARATOS

**Inner**  
18

**Master**  
432

**Fijado por presión**

**Bolsa**

**Compatible con:**  
 ZP  LP  SP

**Colores disponibles:**  
 Blanco  Marfil  Negro

### BUL Módulo contacto y USB doble



**In Put** 110-250 V~ | **Out Put** 5 V~ -2.1 A | **Frecuencia** 50/60 Hz

**Contacto** 125-250 V~/15 A

**Polycarbonato**

**BUL-B**

**BUL-M**

**BUL-N**

**MULTIVOLTAJE**  
PROTEGE TUS APARATOS

**Inner**  
18

**Master**  
432

**Fijado por presión**

**Bolsa**

**Compatible con:**  
 ZP  LP  SP

**Colores disponibles:**  
 Blanco  Marfil  Negro



### B1564 Toma de teléfono 4 hilos RJ-11

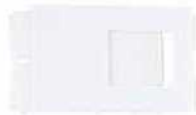

**Policarbonato**

○ B1564-B

○ B1564-M

● B1564-N

**Inner**  
18

**Master**  
432

**Fijado por presión**  

**Bolsa**  

**Compatible con:**  
ZP LP SP

**Colores disponibles:**  
○ Blanco ○ Marfil ● Negro

### B1102 Toma coaxial TV



**Policarbonato**

○ B1102-B

○ B1102-M

● B1102-N

**Inner**  
18

**Master**  
432

**Fijado por presión**  

**Bolsa**  

**Compatible con:**  
ZP LP SP

**Colores disponibles:**  
○ Blanco ○ Marfil ● Negro

### B3026 Toma de cómputo RJ-45 Cat5-E



**Policarbonato**

○ B3026-B

○ B3026-M

● B3026-N

**Inner**  
18

**Master**  
432

**Fijado por presión**  

**Bolsa**  

**Compatible con:**  
ZP LP SP

**Colores disponibles:**  
○ Blanco ○ Marfil ● Negro



### B3020 Tapón ciego



**Polycarbonato**

○ B3020-B

● B3020-M

● B3020-N

<b>Inner</b> 54	<b>Master</b> 1296	<b>Fijado por presión</b> 	<b>Bolsa</b> 	<b>Compatible con:</b> ZP LP SP	<b>Colores disponibles:</b> ○ Blanco ● Marfil ● Negro
--------------------	-----------------------	--	---	------------------------------------	--

### B3021 Tapón salida cable



**Polycarbonato**

○ B3021-B

● B3021-M

● B3021-N

<b>Inner</b> 36	<b>Master</b> 864	<b>Fijado por presión</b> 	<b>Bolsa</b> 	<b>Compatible con:</b> ZP LP SP	<b>Colores disponibles:</b> ○ Blanco ● Marfil ● Negro
--------------------	----------------------	--	---	------------------------------------	--

### B5401 Botón timbre

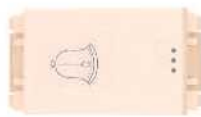
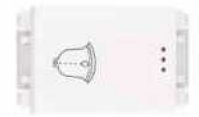

125-250 V~

**Polycarbonato**

○ B5401-B

● B5401-M

● B5401-N

**MULTIVOLTAJE**  
PROTEGE TUS APARATOS

<b>Inner</b> 18	<b>Master</b> 432	<b>Fijado por presión</b> 	<b>Bolsa</b> 	<b>Compatible con:</b> ZP LP SP	<b>Colores disponibles:</b> ○ Blanco ● Marfil ● Negro
--------------------	----------------------	--	---	------------------------------------	--

### B3069 Zumbador (Ding Dong)



**Policarbonato**

○ B3069-B

● B3069-M

● B3069-N

**Inner** 18 **Master** 432 **Fijado por presión** **Bolsa** **Compatible con:** **Colores disponibles:** ○ Blanco ● Marfil ● Negro

### B5807-S Control de velocidad 200 W



**200 W**

**Policarbonato**

○ B5807-S-B

● B5807-S-M

● B5807-S-N

**Inner** 8 **Master** 192 **Fijado por presión** **Bolsa** **Compatible con:** **Colores disponibles:** ○ Blanco ● Marfil ● Negro

### B5172-S Dimmer 200W incandescente o halógeno



**200 W**

**Policarbonato**

○ B5172-S-B

● B5172-S-M

● B5172-S-N

**Inner** 8 **Master** 192 **Fijado por presión** **Bolsa** **Compatible con:** **Colores disponibles:** ○ Blanco ● Marfil ● Negro





# ARTEFACTOS ELÉCTRICOS



## GF15A Contacto dúplex falla tierra

8x12cm

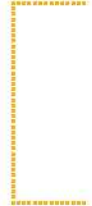

○ GF15A-B



○ GF15A-M



● GF15A-N

Contacto 125-250 V~/15 A

Policarbonato



Inner 6 Master 60 Fácil instalación Bolsa Incluye Colores disponibles: ○ Blanco ○ Marfil ● Negro

## PN1200

### Placa ciega de Nylon



○ PN1200-B



○ PN1200-B

ABS



Inner 50 Master 1000 Bolsa Incluye Colores disponibles: ○ Marfil ○ Blanco

## PN1202

### Placa 2 módulos de Nylon



○ PN1202-B



○ PN1202-B

ABS



Inner 50 Master 1000 Bolsa Incluye Colores disponibles: ○ Marfil ○ Blanco



**AC105/2**  
Contacto dúplex aterrizado



○ AC105/2-B    ● AC105/2-M

**Inner** 10    **Master** 200    **Bolsa**    **Incluye**    **Colores disponibles:**  
○ Blanco    ● Marfil

**AC07/2** Apagador con contacto aterrizado



○ AC07/2-B    ● AC07/2-M

**Inner** 10    **Master** 200    **Bolsa**    **Incluye**    **Colores disponibles:**  
○ Blanco    ● Marfil

**PN1202-NA**  
Placa 2 módulos de Nylon



● PN1202-NA

**Inner** 50    **Master** 1000    **Bolsa**    **Incluye**    **Colores disponibles:**  
● Naranja

**AC105/2-NA** Contacto dúplex de tierra aislada



● AC105/2-NA

**Inner** 20    **Master** 200    **Bolsa**    **Incluye**    **Colores disponibles:**  
● Naranja

**PI1202-P**  
Placa doble interperie



● PI1202-P

**Inner** 10    **Master** 200    **Bolsa**    **Incluye**    **Colores disponibles:**  
● Gris

**AAL5351-B**  
Apagador largo sencillo

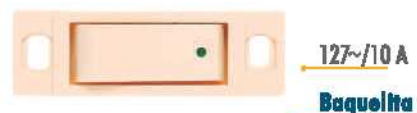

● AAL5351-B

**Inner** 50    **Master** 1000    **Bolsa**    **Incluye**    **Colores disponibles:**  
● Marfil

\* Las imágenes mostradas en este catálogo son con fines ilustrativos. IGota se reserva el derecho de modificar la información sin previo aviso y no se hace responsable por omisiones o errores en este documento.

### AAL5351-F Apagador largo sencillo fluorescente



NOM



127~/10 A

Baquelita

○ AAL5351-F

Inner	Master	Bolsa	Incluye	Colores disponibles:
50	1000			○ Marfil

### AAL5352-B Apagador largo tipo escalera



NOM



127~/10 A

Baquelita

○ AAL5352-B

Inner	Master	Bolsa	Incluye	Colores disponibles:
50	1000			○ Marfil

### T-L Apagador largo timbre sencillo



NOM



127~/10 A

Baquelita

○ T-L

Inner	Master	Bolsa	Incluye	Colores disponibles:
50	1000			○ Marfil

### ACL2101-B Contacto largo sencillo



NOM



127~/10 A

Baquelita

○ ACL2101-B

Inner	Master	Bolsa	Incluye	Colores disponibles:
50	1000			○ Marfil

### ACR2101-B Contacto redondo



NOM



127~/6 A

Baquelita

○ ACR2101-B

Inner	Master	Bolsa	Incluye	Colores disponibles:
25	400			○ Marfil

### AAR5351-B Apagador redondo



NOM



127~/6 A

Baquelita

○ AAR5351-B

Inner	Master	Bolsa	Incluye	Colores disponibles:
12	600			○ Marfil



**T-R-B**  
Apagador timbre redondo



○ T-R-B

127~/6 A

Baquellita

Inner	Master	Bolsa	Incluye	Colores disponibles:
25	400			○ Marfil

**T-C**  
Apagador timbre cuadrado



○ T-C

127~/6 A

Baquellita

Inner	Master	Bolsa	Incluye	Colores disponibles:
30	600			○ Marfil

**AAC5351-B**  
Apagador cuadrado



○ AAC5351-B    ○ AAC5351-M

127~/6 A

Baquellita

Inner	Master	Bolsa	Incluye	Colores disponibles:
30	600			○ Blanco    ○ Marfil

**AC06-2M**  
Contacto dúplex polarizado



○ AC06-2M

127~/6 A

Frente Baquellita  
Base ABS

Inner	Master	Bolsa	Incluye	Colores disponibles:
20	200			○ Marfil

**AC06-M**  
Contacto dúplex aterrizado



○ AC06-M

127~/6 A

Frente Baquellita  
Base ABS

Inner	Master	Bolsa	Incluye	Colores disponibles:
20	200			○ Marfil

**AC03-M**  
Contacto aterrizado triple



○ AC03-M

125~/10 A

Baquellita

Inner	Master	Bolsa	Incluye	Colores disponibles:
25	400			○ Marfil

\* Las imágenes mostradas en este catálogo son con fines ilustrativos. IGota se reserva el derecho de modificar la información sin previo aviso y no se hace responsable por omisiones o errores en este documento.



### AC03/2-M Contacto aterrizado con triple clavija



NOM



127~/10 A

Baquilla

○ AC03/2-M

Inner	Master	Bolsa	Incluye	Colores disponibles:
12	480			○ Marfil

### AC2101-A/A Contacto aterrizado con abrazadera metálica



NOM



125~/15 A

ABS

● AC2101-A/A

Inner	Master	Bolsa	Incluye	Colores disponibles:
25	300			● Amarillo

### AC2101-A/N Contacto con abrazadera metálica



NOM



125~/15 A

ABS

● AC2101-A/N

Inner	Master	Bolsa	Incluye	Colores disponibles:
25	300			● Amarillo

### CL-2P-MA Clavija polarizado con abrazadera metálica



NOM



125~/15 A

ABS

● CL-2P-MA

Inner	Master	Bolsa	Incluye	Colores disponibles:
25	400			● Amarillo

### CL-2PT-MA Clavija aterrizada con abrazader metálica



NOM



125~/15 A

ABS

● CL-2PT-MA

Inner	Master	Bolsa	Incluye	Colores disponibles:
25	400			● Amarillo

### CL-2PT-PA Clavija aterrizada con armazón de plástico



NOM



125~/15 A

ABS

● CL-2PT-PA

Inner	Master	Bolsa	Incluye	Colores disponibles:
25	300			● Amarillo

**TC-PL-C**  
Portalámpara con clavija



NOM



125~/15 A  
660 W  
Baquelita

● TC-PL-C

Inner	Master	Bolsa	Colores disponibles:
30	600		● Café

**SO-P**  
Socket portalámpara



NOM



125~  
660 W  
Baquelita

● SO-P-C ● SO-P-N

Inner	Master	Bolsa	Colores disponibles:
20	600		● Café ● Negro
25	400		

**SO-T**  
Portalámpara con doble ladrón



NOM



125~/15 A  
660 W  
Baquelita

● SO-T-C ○ SO-T-M

Inner	Master	Bolsa	Colores disponibles:
20	400		● Café ○ Marfil

**SO-TA** Portalámpara con doble ladrón e interruptor de cadena



NOM



125~/15 A  
660 W  
Baquelita

● SO-TA-C ○ SO-TA-M

Inner	Master	Bolsa	Colores disponibles:
12	400		● Café ○ Marfil
12	600		

**SO-C**  
Socket circular



NOM

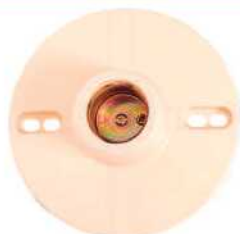

125~/15 A  
Baquelita

○ SO-C

Inner	Master	Bolsa	Colores disponibles:
12	240		○ Marfil

**AM01**  
Adaptador triple



NOM



125~/15 A  
PCV/Cobre

● AM01

Inner	Master	Blister	Colores disponibles:
24	72		● Naranja

\* Las imágenes mostradas en este catálogo son con fines ilustrativos. IGota se reserva el derecho de modificar la información sin previo aviso y no se hace responsable por omisiones o errores en este documento.



### AM02 - AM03 Adaptador triple rectangular



● AM02 125~/15 A      ○ AM03 125~/15 A

Inner	Master	Colores disponibles:		Blister
24	72	● Naranja	PCV/Cobre	
24	144	○ Blanco	ABS/Cobre	



### AM04 Adaptador triple triangular



○ AM04

125~/15 A

ABS/Cobre

Inner	Master	Blister	Colores disponibles:
24	144		○ Blanco



### AM05 Multipuerto 6 contactos



○ AM05

125~/15 A

ABS/Cobre

Inner	Master	Blister	Colores disponibles:
10	50		○ Blanco



### AM06 Multicontacto doble con 2 entradas USB



○ AM06



Joules 220 J

USB 2.1 A

125~/15 A

ABS/Cobre

Inner	Master	Blister	Colores disponibles:
10	40		○ Blanco



### AM07 Multicontacto triple con 2 entradas USB



○ AM07

Joules 220 J

USB 2.1 A

125~/15 A

ABS/Cobre



Inner	Master	Blister	Colores disponibles:
10	40		○ Blanco



### AM08 Adaptador clavija plano triple contacto



○ AM08

125~/15 A

ABS/Cobre

Inner	Master	Blister	Colores disponibles:
50	200		○ Blanco



### AM09 Adaptador clavija plano triple contacto



○ AM09

125~/15 A  
ABS/Cobre



NOM



Inner 50 Master 200 Blister Colores disponibles: ○ Blanco

### AM10 Multicontacto triple aterrizado con indicador



○ AM10

125~/15 A  
ABS/Cobre



NOM



Inner 50 Master 200 Blister Colores disponibles: ○ Blanco

### AM11 Multicontacto triple con 2 entradas USB y soporte para celular



○ AM11

Joules 220 J  
USB 2.1 A  
125~/15 A  
ABS/Cobre



NOM



Inner 50 Master 100 Blister Colores disponibles: ○ Blanco

### AM12 Adaptador triple de cubo



○ AM12

125~/15 A  
ABS/Cobre



NOM



Inner 50 Master 200 Blister Colores disponibles: ○ Blanco

### AM13 Adaptador de clavija



● AM13

125~/15 A  
PVC/Cobre



NOM



Inner 50 Master 500 Colores disponibles: ● Naranja

### 3AM13 Set de 3 adaptador de clavija

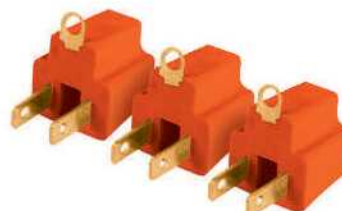

● 3AM13

125~/15 A  
PVC/Cobre



NOM



Inner 50 Master 200 Blister Colores disponibles: ● Naranja





### ED13-B

#### Extensión domestica



○ ED13-B

Código	Tamaño	Inner	Master	Colores disponibles:
ED13-2B	2 m	-	50	○ Blanco
ED13-3B	3 m	-	50	○ Blanco
ED13-4B	4 m	-	50	○ Blanco
ED13-5B	5 m	-	50	○ Blanco
ED13-6B	6 m	-	50	○ Blanco
ED13-8B	8 m	-	50	○ Blanco
ED13-10B	10 m	-	50	○ Blanco

### ER13-NA

#### Extensión uso rudo



● ER13-NA

Código	Tamaño	Inner	Master	Colores disponibles:
ER13-2NA	2 m	-	50	● Naranja
ER13-3NA	3 m	-	40	● Naranja
ER13-4NA	4 m	-	30	● Naranja
ER13-5NA	5 m	-	25	● Naranja
ER13-6NA	6 m	-	20	● Naranja
ER13-8NA	8 m	-	20	● Naranja
ER13-10NA	10 m	-	16	● Naranja
ER13-12NA	12 m	-	16	● Naranja
ER13-15NA	15 m	-	12	● Naranja
ER13-20NA	20 m	-	10	● Naranja
ER13-25NA	25 m	-	8	● Naranja
ER13-30NA	30 m	-	6	● Naranja

### ED-B

#### Mini extensión domestica



○ ED13-1B

○ ED-1B

Inner	Master	Tamaño	Colores disponibles:
-	100	10 cm	○ Blanco

### ER13-1NA

#### Mini extensión uso rudo



● ER13-1NA

Inner	Master	Tamaño	Colores disponibles:
-	100	10 cm	● Naranja



# CONTROLA EL PODER

LÍNEA DIRECTA DE INTERRUPTORES PARA LA PROTECCIÓN DE DESCARGAS ELÉCTRICAS

**MAYOR DURABILIDAD**

**5** veces más sensible al cortocircuito

BOBINA DE DISPARO MAGNÉTICO DE COBRE

DISPOSITIVO TÉRMICO BIMETAL



CONTACTO PUNTAS DE PLATA

CÁMARA DE EXTINCIÓN

BORNE DE SALIDA DE COBRE

DISPONIBLE EN:  
15 A, 20 A, 30 A, 40 A Y 50 A



## IN100 Interruptor termomagnético 1 polo



NOM



120/240 V~

Capacidad interrumpida 10 kA

Código	Corriente	Inner	Master	Frecuencia	Material
IN1001	15 A	12	120	60 Hz	Poliéster
IN1002	20 A				
IN1003	30 A				
IN1004	40 A				
IN1005	50 A				

## IN200 Interruptor termomagnético 2 polos



NOM



120/240 V~

Capacidad interrumpida 10 kA

Código	Corriente	Inner	Master	Frecuencia	Material
IN2001	15 A	6	60	60 Hz	Poliéster
IN2002	20 A				
IN2003	30 A				
IN2004	40 A				
IN2005	50 A				

## IN300 Interruptor termomagnético 3 polos



NOM



120/240 V~

Capacidad interrumpida 10 kA

Código	Corriente	Inner	Master	Frecuencia	Material
IN3001	15 A	4	40	60 Hz	Poliéster
IN3002	20 A				
IN3003	30 A				
IN3004	40 A				
IN3005	50 A				

\* Las imágenes mostradas en este catálogo son con fines ilustrativos. IGoto se reserva el derecho de modificar la información sin previo aviso y no se hace responsable por omisiones o errores en este documento.





### Ex6-18W - Ex4-16W

#### Extractor de aire empotrable



21 cm x 21 cm

○ Ex6-18W



15 cm x 15 cm

○ Ex4-16W

- 125~/15 A
- Ruido 35 dB
- Doble embobinado de cobre
- Cuerpo ABS



Modelo	2A	B	C	D
Ex6-18W	148 mm	200 mm	75 mm	12 mm
Modelo	2A	B	C	D
Ex4-16W	98 mm	157 mm	60 mm	21 mm

Modelo	Inner	Master	Volumen aire	Modelo	Inner	Master	Volumen aire	Fácil instalación	Colores disponibles:
Ex6-18W	-	20	320m <sup>3</sup> /h	Ex4-16W	-	30	130m <sup>3</sup> /h		○ Blanco

### Ex4-16W-M

#### Extractor de aire empotrable



15 cm x 15 cm

○ Ex4-16W-M

- 125~/15 A
- Ruido 35 dB
- Doble embobinado de cobre
- Cuerpo ABS



Modelo	2A	B	C	D
Ex6-18W-M	148 mm	200 mm	75 mm	12 mm
Modelo	2A	B	C	D
Ex4-16W-M	98 mm	157 mm	60 mm	21 mm

Modelo	Inner	Master	Volumen aire	Fácil instalación	Colores disponibles:
Ex4-16W-M	-	20	130m <sup>3</sup> /h		○ Marfil





**Foco LED A55**

Modelo	Luz Cálida	Modelo	Luz Fría
F20105	3000 K	F10105	6500 K

**Consumo 5 w**

**Flujo 450 lm**

**Inner 10**  
**Master 100**



**MULTIVOLTAJE**  
PROTEGE TUS APARATOS

- 100-240 V~
- E27
- 30,000 h
- OMNIDIRECCIONAL

Reemplaza	Frecuencia	Tipo de bulbo	Intensidad de corriente
40 W	60 Hz	A	80 mA

2400-3000K	4100-5700K	6500-7000K
------------	------------	------------



**Foco LED A55**

Modelo	Luz Cálida	Modelo	Luz Fría
F20107	3000 K	F10107	6500 K

**Consumo 7 w**

**Flujo 630 lm**

**Inner 10**  
**Master 100**



**MULTIVOLTAJE**  
PROTEGE TUS APARATOS

- 100-240 V~
- E27
- 30,000 h
- OMNIDIRECCIONAL

Reemplaza	Frecuencia	Tipo de bulbo	Intensidad de corriente
60 W	60 Hz	A	110 mA

2400-3000K	4100-5700K	6500-7000K
------------	------------	------------





**Foco LED A60**

Modelo	Luz Cálida	Modelo	Luz Fría
F20109	3000 K	F10609*	6500 K



**Consumo**  
9 w

**Flujo**  
810 lm

**Inner** 10  
**Master** 100

Altura



**MULTIVOLTAJE**  
PROTEGE TUS APARATOS



100-240 V~ E27 30,000 h OMNIDIRECCIONAL

Reemplaza	Frecuencia	Tipo de bulbo	Intensidad de corriente
60 W	60 Hz	A	140 mA

2400-3000K 4100-5700K 6500-7000K

**Foco LED A60**

Modelo	Luz Cálida	Modelo	Luz Fría
F20112	3000 K	F10112	6500 K



**Consumo**  
12 w

**Flujo**  
1080 lm

**Inner** 10  
**Master** 100

Altura



**MULTIVOLTAJE**  
PROTEGE TUS APARATOS



100-240 V~ E27 30,000 h OMNIDIRECCIONAL

Reemplaza	Frecuencia	Tipo de bulbo	Intensidad de corriente
100 W	60 Hz	A	190 mA

2400-3000K 4100-5700K 6500-7000K

**Foco LED A60**

Modelo	Luz Cálida	Modelo	Luz Fría
F20115	3000 K	F10115	6500 K



**Consumo**  
15 w

**Flujo**  
1350 lm

**Inner** 10  
**Master** 100

Altura



**MULTIVOLTAJE**  
PROTEGE TUS APARATOS



100-240 V~ E27 30,000 h OMNIDIRECCIONAL

Reemplaza	Frecuencia	Tipo de bulbo	Intensidad de corriente
120 W	60 Hz	A	240 mA

2400-3000K 4100-5700K 6500-7000K

**Foco LED G45**

Modelo	Luz Cálida	Modelo	Luz Fría
F20204	3000 K	F10204	6500 K



**Consumo**  
4 w

**Flujo**  
360 lm

**Inner** 10  
**Master** 100

Altura



**MULTIVOLTAJE**  
PROTEGE TUS APARATOS



100-240 V~ E27 30,000 h OMNIDIRECCIONAL

Reemplaza	Frecuencia	Tipo de bulbo	Intensidad de corriente
25 W	60 Hz	G	70 mA

2400-3000K 4100-5700K 6500-7000K

## PAQUETE DE FOCOS LED E27

### Foco LED FE10709

Consumo 9 w

Flujo 720 lm

Inner Master

Altura



MULTIVOLTAJE PROTEGE TUS APARATOS



100-240 V~



E27



15,000 h



OMNIDIRECCIONAL

Reemplaza	Frecuencia	Tipo de bulbo	Intensidad de corriente
60 W	60 Hz	A	180 mA

Modelo Luz Fría  
FE10709 6500 K



NUEVO

# nuevo Foco de Emergencia

LUZ FRÍA 6,500 K

DURACIÓN 2 HRS

WATTAGE 9 W

### Foco LED A55

Consumo 5 w

Flujo 450 lm

Inner 1  
Master 30

Altura



MULTIVOLTAJE PROTEGE TUS APARATOS



100-240 V~



E27



30,000 h



OMNIDIRECCIONAL

Reemplaza	Frecuencia	Tipo de bulbo	Intensidad de corriente
40 W	60 Hz	A	80 mA

2400-3000K 4100-5700K 6500-7000K



NUEVO

### Foco LED A55

Consumo 7 w

Flujo 630 lm

Inner 1  
Master 30

Altura



MULTIVOLTAJE PROTEGE TUS APARATOS



100-240 V~



E27



30,000 h



OMNIDIRECCIONAL

Reemplaza	Frecuencia	Tipo de bulbo	Intensidad de corriente
60 W	60 Hz	A	110 mA

2400-3000K 4100-5700K 6500-7000K



NUEVO

\* Las imágenes mostradas en este catálogo son con fines ilustrativos. Igo to se reserva el derecho de modificar la información sin previo aviso y no se hace responsable por omisiones o errores en este documento.







**Foco LED A60**

Modelo	Luz Cálida	Modelo	Luz Fría
F3P20109	3000 K	F3P10109*	6500 K



Consumo **9 w**

Flujo **810 lm**

Inner **1**  
Master **30**

Altura   
11 cm



MULTIVOLTAJE  
PROTEGE TUS APARATOS



100-240 V~



E27



30,000 h



OMNIDIRECCIONAL

Reemplaza	Frecuencia	Tipo de bulbo	Intensidad de corriente
60 W	60 Hz	A	140 mA

2400-3000K	4100-5700K	6500-7000K
------------	------------	------------

**Foco LED A60**

Modelo	Luz Cálida	Modelo	Luz Fría
F10P20109	3000 K	F10P10109*	6500 K



Consumo **9 w**

Flujo **810 lm**

Inner **1**  
Master **10**

Altura   
11 cm



MULTIVOLTAJE  
PROTEGE TUS APARATOS



100-240 V~



E27



30,000 h



OMNIDIRECCIONAL

Reemplaza	Frecuencia	Tipo de bulbo	Intensidad de corriente
60 W	60 Hz	A	140 mA

2400-3000K	4100-5700K	6500-7000K
------------	------------	------------

**Foco LED A60**

Modelo	Luz Cálida	Modelo	Luz Fría
F3P20112	3000 K	F3P10112	6500 K



Consumo **12 w**

Flujo **1080 lm**

Inner **1**  
Master **30**

Altura   
11 cm



MULTIVOLTAJE  
PROTEGE TUS APARATOS

NUEVO



100-240 V~



E27



30,000 h



OMNIDIRECCIONAL

Reemplaza	Frecuencia	Tipo de bulbo	Intensidad de corriente
100 W	60 Hz	A	190 mA

2400-3000K	4100-5700K	6500-7000K
------------	------------	------------

**Foco LED A60**

Modelo	Luz Cálida	Modelo	Luz Fría
F3P20115	3000 K	F3P10115	6500 K



Consumo **15 w**

Flujo **1350 lm**

Inner **1**  
Master **30**

Altura   
12 cm



MULTIVOLTAJE  
PROTEGE TUS APARATOS

NUEVO



100-240 V~



E27



30,000 h



OMNIDIRECCIONAL

Reemplaza	Frecuencia	Tipo de bulbo	Intensidad de corriente
120 W	60 Hz	A	240 mA

2400-3000K	4100-5700K	6500-7000K
------------	------------	------------







**Foco LED T80**

Modelo	Luz Cálida	Modelo	Luz Fría
F20520*	3000 K	F10520	6500 K

**Consumo 20 w**

**Flujo 1800 lm**

**Inner 1**  
**Master 50**

**Medidas**  
8 cm | 11,9 cm

**MULTIVOLTAJE**  
PROTEGE TUS APARATOS

**\*NUEVO**

100-240 V~	E27	30,000 h	OMNIDIRECCIONAL
------------	-----	----------	-----------------

Reemplaza	Frecuencia	Tipo de bulbo	Intensidad de corriente
150 W	60 Hz	T	400 mA

2400-3000K	4100-5700K	6500-7000K
------------	------------	------------

**Foco LED T100**

Modelo	Luz Cálida	Modelo	Luz Fría
F20530*	3000 K	F10530	6500 K

**Consumo 30 w**

**Flujo 2700 lm**

**Inner 1**  
**Master 25**

**Medidas**  
10 cm | 15,2 cm

**MULTIVOLTAJE**  
PROTEGE TUS APARATOS

**\*NUEVO**

100-240 V~	E27	30,000 h	OMNIDIRECCIONAL
------------	-----	----------	-----------------

Reemplaza	Frecuencia	Tipo de bulbo	Intensidad de corriente
200 W	60 Hz	T	500 mA

2400-3000K	4100-5700K	6500-7000K
------------	------------	------------

\* Las imágenes mostradas en este catálogo son con fines ilustrativos.  
Igoto se reserva el derecho de modificar la información sin previo aviso y no se hace responsable por omisiones o errores en este documento.



**Foco LED T120**

Modelo	Luz Cálida	Modelo	Luz Fría
F20540*	3000 K	F10540	6500 K



**Consumo 40 w**

**Flujo 3600 lm**

**Inner 1**  
**Master 20**



**MULTIVOLTAJE**  
PROTEGE TUS APARATOS

\*NUEVO



100-240 V~

E27

30,000 h

OMNIDIRECCIONAL

Reemplaza	Frecuencia	Tipo de bulbo	Intensidad de corriente
300 W	60 Hz	T	700 mA

2400-3000K	4100-5700K	6500-7000K
------------	------------	------------

**Foco LED T140**

Modelo	Luz Cálida	Modelo	Luz Fría
F20550*	3000 K	F10550	6500 K



**Consumo 50 w**

**Flujo 4500 lm**

**Inner 1**  
**Master 10**



**MULTIVOLTAJE**  
PROTEGE TUS APARATOS

\*NUEVO



100-240 V~

E27

30,000 h

OMNIDIRECCIONAL

Reemplaza	Frecuencia	Tipo de bulbo	Intensidad de corriente
400 W	60 Hz	T	900 mA

2400-3000K	4100-5700K	6500-7000K
------------	------------	------------

**NUEVO**  
**Foco LED T160**  
**F10570**



**Consumo 70 w**

**Flujo 6300 lm**

**Inner 1**  
**Master 10**



**MULTIVOLTAJE**  
PROTEGE TUS APARATOS

\*NUEVO



100-277 V~

E40/MOGUL

30,000 h

OMNIDIRECCIONAL

Reemplaza	Frecuencia	Tipo de bulbo	Intensidad de corriente
300 W	60 Hz	T	1000 mA

**NUEVO**  
**Foco LED T180**  
**F105100**



**Consumo 100 w**

**Flujo 9000 lm**

**Inner 1**  
**Master 10**



**MULTIVOLTAJE**  
PROTEGE TUS APARATOS

\*NUEVO



100-277 V~

E40/MOGUL

30,000 h

OMNIDIRECCIONAL

Reemplaza	Frecuencia	Tipo de bulbo	Intensidad de corriente
400 W	60 Hz	T	1400 mA





**Foco LED GU10** Modelo Luz Cálida Modelo Luz Fría  
**F20303 3000 K F10303 6500 K**



**Consumo 3 w**

**Flujo 230 lm**

**Inner 10  
Master 100**



**MULTIVOLTAJE  
PROTEGE TUS APARATOS**



100-240 V~ GU10 30,000 h DIRECCIONAL 100°

Reemplaza	Frecuencia	Tipo de bulbo	Intensidad de corriente
15 W	60 Hz	MR	50 mA

2400-3000K 4100-5700K 6500-7000K

**Foco LED GU10** Modelo Luz Cálida Modelo Luz Fría  
**F20305 3000 K F10305 6500 K**



**Consumo 5 w**

**Flujo 375 lm**

**Inner 10  
Master 100**



**MULTIVOLTAJE  
PROTEGE TUS APARATOS**



100-240 V~ GU10 30,000 h DIRECCIONAL 100°

Reemplaza	Frecuencia	Tipo de bulbo	Intensidad de corriente
40 W	60 Hz	MR	80 mA

2400-3000K 4100-5700K 6500-7000K

**Foco LED GU10** Modelo Luz Cálida Modelo Luz Fría  
**F20307 3000 K F10307 6500 K**



**Consumo 7 w**

**Flujo 525 lm**

**Inner 10  
Master 100**



**MULTIVOLTAJE  
PROTEGE TUS APARATOS**



100-240 V~ GU10 30,000 h DIRECCIONAL 100°

Reemplaza	Frecuencia	Tipo de bulbo	Intensidad de corriente
60 W	60 Hz	MR	110 mA

2400-3000K 4100-5700K 6500-7000K

**Foco LED GU10** Modelo Luz Cálida Modelo Luz Fría  
**FG20307 3000 K FG10307 6500 K**



**Consumo 7 w**

**Flujo 525 lm**

**Inner 10  
Master 100**



**MULTIVOLTAJE  
PROTEGE TUS APARATOS**



100-240 V~ GU10 30,000 h DIRECCIONAL 35°

Reemplaza	Frecuencia	Tipo de bulbo	Intensidad de corriente
60 W	60 Hz	MR	110 mA

2400-3000K 4100-5700K 6500-7000K

\* Las imágenes mostradas en este catálogo son con fines ilustrativos.

iGoto se reserva el derecho de modificar la información sin previo aviso y no se hace responsable por omisiones o errores en este documento.





**Foco LED MR16** Modelo Luz Cálida Modelo Luz Fría  
**F20403 3000 K F10403 6500 K**



**Consumo 3 w**

**Flujo 230 lm**

**Inner 10**  
**Master 100**



**MULTIVOLTAJE**  
 PROTEGE TUS APARATOS



**100-240 V~ GU5.3 30,000 h DIRECCIONAL 100°**

Reemplaza	Frecuencia	Tipo de bulbo	Intensidad de corriente
15 W	60 Hz	MR	50 mA

3400-3800K 4100-5700K 6500-7000K

**Foco LED MR16** Modelo Luz Cálida Modelo Luz Fría  
**F20405 3000 K F10405 6500 K**



**Consumo 5 w**

**Flujo 370 lm**

**Inner 10**  
**Master 100**



**MULTIVOLTAJE**  
 PROTEGE TUS APARATOS



**100-240 V~ GU5.3 30,000 h DIRECCIONAL 100°**

Reemplaza	Frecuencia	Tipo de bulbo	Intensidad de corriente
40 W	60 Hz	MR	80 mA

3400-3800K 4100-5700K 6500-7000K

**Foco LED MR16** Modelo Luz Cálida Modelo Luz Fría  
**F20407 3000 K F10407 6500 K**



**Consumo 7 w**

**Flujo 500 lm**

**Inner 10**  
**Master 100**



**MULTIVOLTAJE**  
 PROTEGE TUS APARATOS



**100-240 V~ GU5.3 30,000 h DIRECCIONAL 100°**

Reemplaza	Frecuencia	Tipo de bulbo	Intensidad de corriente
60 W	60 Hz	MR	110 mA

3400-3800K 4100-5700K 6500-7000K

**Foco LED MR16** Modelo Luz Cálida Modelo Luz Fría  
**FG20407 3000 K FG10407 6500 K**



**Consumo 7 w**

**Flujo 500 lm**

**Inner 10**  
**Master 100**



**MULTIVOLTAJE**  
 PROTEGE TUS APARATOS



**100-240 V~ GU5.3 30,000 h DIRECCIONAL 35°**

Reemplaza	Frecuencia	Tipo de bulbo	Intensidad de corriente
60 W	60 Hz	MR	110 mA

3400-3800K 4100-5700K 6500-7000K

# ELIGE EL GABINETE IGOTO IDEAL



Luz con tecnología LED.



Tiempo aproximado de vida 30,000 horas.



Multivoltaje  
110-240 V~



Fácil instalación.

LOS GABINETES IGOTO ESTAN PROTEGIDOS CONTRA:



Objetos con diámetro superior a 12 mm



Aprueba de polvo.



Goteo con una inclinación de 15°



Chorros de agua.

DIFERENTE INTENSIDAD TEMPERATURA

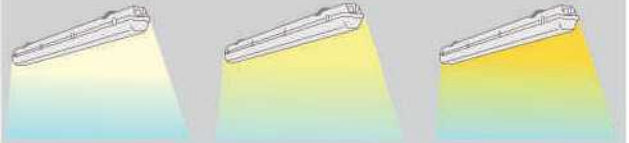

Los gabinetes iGoto varían de intensidad y temperatura dependiendo de los tubos con los que se instalen (T5 - T8).

ESPACIOS RECOMENDADOS

INDOOR

OUTDOOR

ENTRETENIMIENTO



Closet



Estadios deportivos



Sauna/Spa



Oficinas



Zonas verdes



Museos



Hospitales



Estacionamientos



Acuarios

## GABINETES Y LUMINARIOS LED

### Gabinete a prueba de vapor

Modelo  
**GV04**

Potencia recomendada  
**2x18w=36w**



Inner 1  
Master 8

Difusor policarbonato



Utiliza 2 tubos  
No incluye tubos

Frecuencia	Peso	Material
50-60 Hz	1.2 kg	Cuerpo ABS, Difusor policarbonato

2400-3000K

4100-5700K

6500-7000K

### Gabinete a prueba de vapor con tubos

Modelo  
**GV05**

Potencia  
**2x18w=36w**

Flujo  
**3200 lm**

Inner 1  
Master 8

Difusor policarbonato



MULTIVOLTAJE  
PROTEGE TUS APARATOS



85-265 V



Utiliza 2 tubos  
Incluye tubos T8



Luz fría  
6500 K

Frecuencia	Peso	Material
50-60 Hz	1.8 kg	Cuerpo ABS, Difusor policarbonato

\* Las imágenes mostradas en este catálogo son con fines ilustrativos. iGoto se reserva el derecho de modificar la información sin previo aviso y no se hace responsable por omisiones o errores en este documento.





### Luminario de rejilla

**Modelo**  
**GR04**

**Potencia**  
**recomendada**  
**2x18w=36w**

**Inner** 1  
**Master** 10

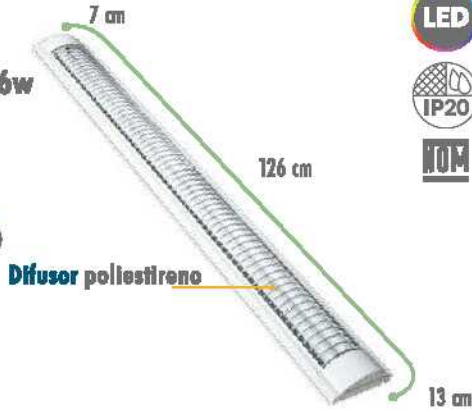

Difusor poliestireno



Utiliza 2 tubos  
No incluye tubos

Frecuencia	Peso	Material
50-60 Hz	900 gr	Cuerpo ABS, Difusor poliestireno

2400-3000K      4100-5700K      6500-7000K

### Luminario de rejilla con tubos

**Modelo**  
**GR03**

**Potencia**  
**2x18w=36w**

**Flujo**  
**3200 lm**

**Inner** 1  
**Master** 10



Difusor poliestireno



**MULTIVOLTAJE**  
PROTEGE TUS APARATOS



85-265 V



Utiliza 2 tubos  
Incluye tubos T8



Luz fría  
6500 K

Frecuencia	Peso	Material
50-60 Hz	1 kg	Cuerpo ABS, Difusor poliestireno

### Luminario LED slim de sobreponer

**Modelo**  
**LS01**

**Modelo**  
**LS02**

**Modelo**  
**LS03**

**Potencia**  
**40 w**

**30 w**

**20 w**

**Flujo luminoso**

**3200 lm**

**2400 lm**

**1600 lm**

**Peso**

**387 gr**

**295 gr**

**204 gr**

**Inner** 1

**Master** 30

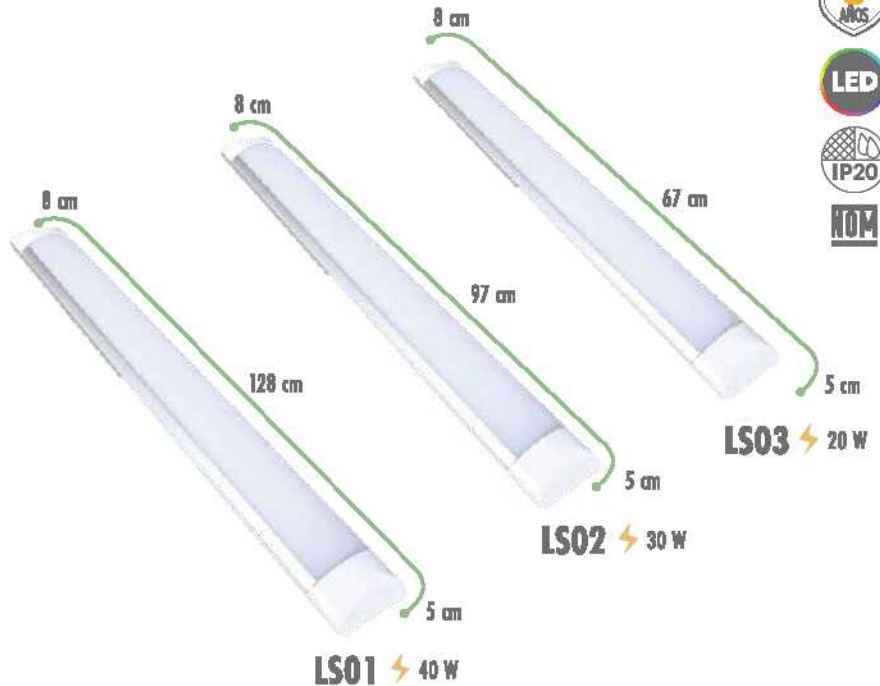

**MULTIVOLTAJE**  
PROTEGE TUS APARATOS



85-265 V



Luz fría  
6500 K

**Frecuencia**  
50-60 Hz

**Material**  
Cuerpo aluminio

**LS01** ⚡ 40 W

**LS02** ⚡ 30 W

**LS03** ⚡ 20 W



# ELIGE EL REFLECTOR IGOTO IDEAL

## MARCO PROTECTOR



Mayor protección, mayor durabilidad.



Disponible en colores: **blanco y negro.**  
\*modulos seleccionables\*

Ejemplo con:  
Reflector de **10w**

El tipo de lugar y cantidad de luz necesario cambia si la faena o actividades exige una mayor discriminación de detalles finos o requerimientos de la visión.

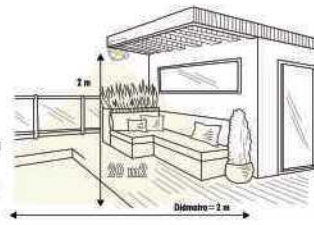

**Instalación en exterior**  
(ilustración para terraza)

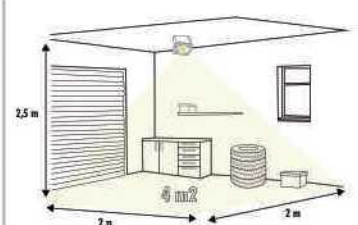

**Instalación en interior**  
(ilustración para bodega)

## PROCESO DE INSTALACIÓN

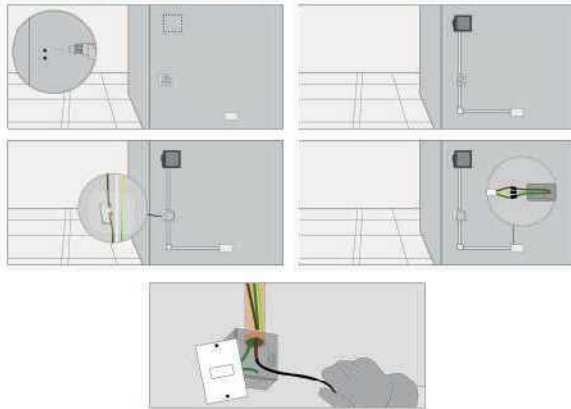

## TIPO DE INSTALACIÓN



Pared



Piso



Techo

## MÚLTIPLES POSICIONES

FRENTE

COSTADOS

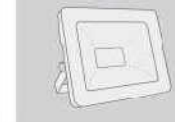

## REFLECTORES LED

Modelo	Luz Cálida	Modelo	Luz Fría
REF2010	3000 K	REF010	6500 K

### Reflector LED 10W

**Potencia**  
10 w

**Flujo**  
1,000 lm

**Inner** 1  
**Master** 60



Cristal templado

Marco protector



### MULTIVOLTAJE PROTEGE TUS APARATOS



Conexión por cableado cableado con ferro de caucho 110-240 V~ 4 mm FP >0,9 IRC >80

Peso	Tiempo de vida	Lumenes por watts	Resistencia
200 gr	30,000 h	100	IK 07

3400-3800K 4100-5700K 6500-7000K

Modelo	Luz Cálida	Modelo	Luz Fría
REF2020	3000 K	REF020	6500 K

### Reflector LED 20W

**Potencia**  
20 w

**Flujo**  
2,000 lm

**Inner** 1  
**Master** 40



Cristal templado

Marco protector



### MULTIVOLTAJE PROTEGE TUS APARATOS



Conexión por cableado cableado con ferro de caucho 110-240 V~ 4 mm FP >0,9 IRC >80

Peso	Tiempo de vida	Lumenes por watts	Resistencia
300 gr	30,000 h	100	IK 07

3400-3800K 4100-5700K 6500-7000K

\* Las imágenes mostradas en este catálogo son con fines ilustrativos. IGoto se reserva el derecho de modificar la información sin previo aviso y no se hace responsable por omisiones o errores en este documento.

Modelo Luz Cálida Modelo Luz Fría  
**REF2030 3000 K REF030 6500 K**



### Reflector LED 30W

**Potencia**  
30 w

**Flujo**  
3,000 lm

**Inner** 1

**Master** 40



Cristal templado

Marco protector

**MULTIVOLTAJE**  
PROTEGE TUS APARATOS



Conexión por cableado cableado con forro de caucho 110-240 V~ 4 mm FP >0,9 ICR >80

Peso	Tiempo de vida	Lumenes por watts	Resistencia
400 gr	30,000 h	100	IK 07

2400-3000K 4100-5700K 6500-7000K

Modelo Luz Cálida Modelo Luz Fría  
**REF2050 3000 K REF050 6500 K**



### Reflector LED 50W

**Potencia**  
50 w

**Flujo**  
5,000 lm

**Inner** 1

**Master** 20



Cristal templado

Marco protector

**MULTIVOLTAJE**  
PROTEGE TUS APARATOS



Conexión por cableado cableado con forro de caucho 110-240 V~ 4 mm FP >0,9 ICR >80

Peso	Tiempo de vida	Lumenes por watts	Resistencia
700 gr	30,000 h	100	IK 07

2400-3000K 4100-5700K 6500-7000K

Modelo Luz Cálida Modelo Luz Fría  
**REF2100 3000 K REF100 6500 K**



### Reflector LED 100W

**Potencia**  
100 w

**Flujo**  
10,000 lm

**Inner** 1

**Master** 10



Cristal templado

Marco protector

**MULTIVOLTAJE**  
PROTEGE TUS APARATOS



Conexión por cableado cableado con forro de caucho 110-240 V~ 4 mm FP >0,9 ICR >80

Peso	Tiempo de vida	Lumenes por watts	Resistencia
1.4 kg	30,000 h	100	IK 07

2400-3000K 4100-5700K 6500-7000K

Modelo Luz Fría  
**REF150 6500 K**



### Reflector LED 150W

**Potencia**  
150 w

**Flujo**  
15,000 lm

**Inner** 1

**Master** 5

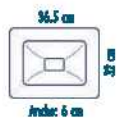

Cristal templado

**MULTIVOLTAJE**  
PROTEGE TUS APARATOS



Conexión por cableado cableado con forro de caucho 110-240 V~ 4 mm FP >0,9 ICR >80

Peso	Tiempo de vida	Lumenes por watts	Resistencia
2.9 kg	30,000 h	100	IK 07



Modelo Luz Fría  
**REF200 6500 K**

**Reflector LED 200W**

**Potencia**  
200 w  
**Flujo**  
20,000 lm  
**Inner** 1  
**Master** 5



Cristal templado

**MULTIVOLTAJE**  
PROTEGE TUS APARATOS



Conexión por cableado cableado con forro de caucho 110-240 V~ 4 mm FP >0,9 ICR >80

<b>Peso</b> 3.3 kg	<b>Tiempo de vida</b> 30,000 h	<b>Lumenes por watts</b> 100	<b>Resistencia</b> IK 07
-----------------------	-----------------------------------	---------------------------------	-----------------------------



Modelo Luz Fría  
**REF300 6500 K**

**NUEVO**

**Reflector LED 300W**

**Potencia**  
300 w  
**Flujo**  
30,000 lm  
**Inner** 1  
**Master** 2

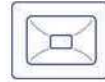

Cristal templado

**MULTIVOLTAJE**  
PROTEGE TUS APARATOS



Conexión por cableado cableado con forro de caucho 110-240 V~ 4 mm FP >0,9 ICR >80

<b>Peso</b>	<b>Tiempo de vida</b> 30,000 h	<b>Lumenes por watts</b> 100	<b>Resistencia</b> IK 07
-------------	-----------------------------------	---------------------------------	-----------------------------



Modelo Luz Fría  
**REF400 6500 K**

**NUEVO**

**Reflector LED 400W**

**Potencia**  
400 w  
**Flujo**  
40,000 lm  
**Inner** 1  
**Master** 2



Cristal templado

**MULTIVOLTAJE**  
PROTEGE TUS APARATOS



Conexión por cableado cableado con forro de caucho 110-240 V~ 4 mm FP >0,9 ICR >80

<b>Peso</b>	<b>Tiempo de vida</b> 30,000 h	<b>Lumenes por watts</b> 100	<b>Resistencia</b> IK 07
-------------	-----------------------------------	---------------------------------	-----------------------------





**NUEVO** Modelo **REF4010** Luz Cálida **3000 K** Modelo **REF3010** Luz Fría **6500 K**

**Reflector LED 10W**

**Potencia**  
10 w

**Flujo**  
1,000 lm

**Inner** 1  
**Master** 60



Cristal templado Marco protector



**MULTIVOLTAJE**  
PROTEGE TUS APARATOS



Conexión por cableado cableado con forro de caucho 110-240 V~ 4 mm FP >0,9 IRC >80

<b>Peso</b> 200 gr	<b>Tiempo de vida</b> 30,000 h	<b>Lúmenes por watts</b> 100	<b>Resistencia</b> IK 07
-----------------------	-----------------------------------	---------------------------------	-----------------------------

2400-3000K 4100-5700K 6500-7000K

**NUEVO** Modelo **REF4020** Luz Cálida **3000 K** Modelo **REF3020** Luz Fría **6500 K**

**Reflector LED 20W**

**Potencia**  
20 w

**Flujo**  
2,000 lm

**Inner** 1  
**Master** 40



Cristal templado Marco protector



**MULTIVOLTAJE**  
PROTEGE TUS APARATOS



Conexión por cableado cableado con forro de caucho 110-240 V~ 4 mm FP >0,9 IRC >80

<b>Peso</b> 300 gr	<b>Tiempo de vida</b> 30,000 h	<b>Lúmenes por watts</b> 100	<b>Resistencia</b> IK 07
-----------------------	-----------------------------------	---------------------------------	-----------------------------

2400-3000K 4100-5700K 6500-7000K

**NUEVO** Modelo **REF4030** Luz Cálida **3000 K** Modelo **REF3030** Luz Fría **6500 K**

**Reflector LED 30W**

**Potencia**  
30 w

**Flujo**  
3,000 lm

**Inner** 1  
**Master** 40



Cristal templado Marco protector



**MULTIVOLTAJE**  
PROTEGE TUS APARATOS



Conexión por cableado cableado con forro de caucho 110-240 V~ 4 mm FP >0,9 IRC >80

<b>Peso</b> 400 gr	<b>Tiempo de vida</b> 30,000 h	<b>Lúmenes por watts</b> 100	<b>Resistencia</b> IK 07
-----------------------	-----------------------------------	---------------------------------	-----------------------------

2400-3000K 4100-5700K 6500-7000K

**NUEVO** Modelo **REF4050** Luz Cálida **3000 K** Modelo **REF3050** Luz Fría **6500 K**

**Reflector LED 50W**

**Potencia**  
50 w

**Flujo**  
5,000 lm

**Inner** 1  
**Master** 20



Cristal templado Marco protector



**MULTIVOLTAJE**  
PROTEGE TUS APARATOS



Conexión por cableado cableado con forro de caucho 110-240 V~ 4 mm FP >0,9 IRC >80

<b>Peso</b> 700 gr	<b>Tiempo de vida</b> 30,000 h	<b>Lúmenes por watts</b> 100	<b>Resistencia</b> IK 07
-----------------------	-----------------------------------	---------------------------------	-----------------------------

2400-3000K 4100-5700K 6500-7000K

<b>NUEVO</b>	Modelo <b>REF4100</b>	Luz Cálida <b>3000 K</b>	Modelo <b>REF3100</b>	Luz Fría <b>6500 K</b>
--------------	-----------------------	--------------------------	-----------------------	------------------------

**Reflector LED 100W**

**Potencia**  
100 w

**Flujo**  
10,000 lm

**Inner** 1  
**Master** 10



25.5 cm  
25.5 cm  
Ancho: 5 cm

Cristal templado Marco protector

**MULTIVOLTAJE**  
PROTEGE TUS APARATOS

Conexión por cableado cableado con forro de caucho

110-240 V~ 4 mm FP >0,9 ICR >80

<b>Peso</b> 1.4 kg	<b>Tiempo de vida</b> 30,000 h	<b>Lumenes por watts</b> 100	<b>Resistencia</b> IK 07
-----------------------	-----------------------------------	---------------------------------	-----------------------------

2400-3000K 4100-5700K 6500-7000K

GARANTÍA 2 AÑOS  
LED  
IP65  
NOM  
Fácil Instalación

<b>NUEVO</b>	Modelo <b>REF3150</b>	Luz Fría <b>6500 K</b>
--------------	-----------------------	------------------------

**Reflector LED 150W**

**Potencia**  
150 w

**Flujo**  
15,000 lm

**Inner** 1  
**Master** 5



25.5 cm  
25.5 cm  
Ancho: 6 cm

Cristal templado

**MULTIVOLTAJE**  
PROTEGE TUS APARATOS

Conexión por cableado cableado con forro de caucho

110-240 V~ 4 mm FP >0,9 ICR >80

<b>Peso</b> 2.9 kg	<b>Tiempo de vida</b> 30,000 h	<b>Lumenes por watts</b> 100	<b>Resistencia</b> IK 07
-----------------------	-----------------------------------	---------------------------------	-----------------------------

GARANTÍA 2 AÑOS  
LED  
IP65  
NOM  
Fácil Instalación

<b>NUEVO</b>	Modelo <b>REF3200</b>	Luz Fría <b>6500 K</b>
--------------	-----------------------	------------------------

**Reflector LED 200W**

**Potencia**  
200 w

**Flujo**  
20,000 lm

**Inner** 1  
**Master** 5



39.5 cm  
39.5 cm  
Ancho: 6 cm

Cristal templado

**MULTIVOLTAJE**  
PROTEGE TUS APARATOS

Conexión por cableado cableado con forro de caucho

110-240 V~ 4 mm FP >0,9 ICR >80

<b>Peso</b> 3.3 kg	<b>Tiempo de vida</b> 30,000 h	<b>Lumenes por watts</b> 100	<b>Resistencia</b> IK 07
-----------------------	-----------------------------------	---------------------------------	-----------------------------

GARANTÍA 2 AÑOS  
LED  
IP65  
NOM  
Fácil Instalación

\* Las imágenes mostradas en este catálogo son con fines ilustrativos. IGoto se reserva el derecho de modificar la información sin previo aviso y no se hace responsable por omisiones o errores en este documento.



# ELIGE EL VENTILADOR IGOTO IDEAL

## MEDIDAS RECOMENDADAS

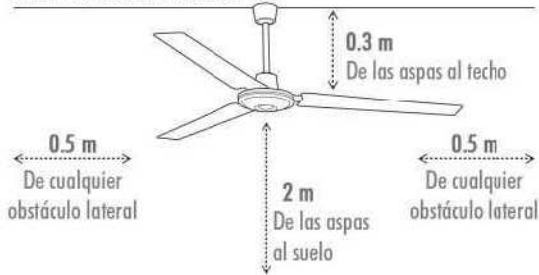

Incluye gancho para instalación



Motor reforzado = Mayor durabilidad

Nuestros ventiladores iGoto están protegidos contra:



PROTECCIÓN ESPECIAL

Humedad

Calor

Salitre

	CUARTO PEQUEÑO	CUARTO MEDIANO	CUARTO GRANDE
TAMAÑO DEL ESPACIO	9m <sup>2</sup> o menos	37m <sup>2</sup> o menos	37m <sup>2</sup> o más
TAMAÑO DEL VENTILADOR	30"	42"	56"
TIPO DE DEL ESPACIO	Pasillo Lavandería Walk in closet	Recámara Oficina Cocina	Sala Recámara grande Patio grande

## VENTILADORES

### Ventilador Industrial de 56"

Modelo V5601

Inner -

Master 1

3 ASPAS



MOTOR REFORZADO



110-127 V~



Control de velocidad de pared



300 RPM 5 velocidades



Aspas: 56 cm

Dímetro: 142 cm  
Peso: 5 kg aprox.

Potencia del motor 70 W

Frecuencia 60 Hz

Peso del motor 2,55 kg

Material Aspas metálicas

### 3 PACK Ventilador Industrial de 56"

Modelo V56-70w

Inner -

Master 3

3 ASPAS



MOTOR REFORZADO



110-127 V~



Control de velocidad de pared



300 RPM 5 velocidades



Aspas: 56 cm

Dímetro: 142 cm  
Peso: 5 kg aprox.

Potencia del motor 70 W

Frecuencia 60 Hz

Peso del motor 2,55 kg

Material Aspas metálicas





**Ventilador Ventum 30"**

**Modelo V3001**

**Inner -**

**Master I**

**6 ASPAS**



Aspas: 32cm



Diametro: 76 cm  
Peso: 5 kg aprox.

**110-127 V~**

**1 FOCO**  
No incluye foco

**110/160/230**  
3 velocidades

<b>Potencia del motor</b> 60 W	<b>Frecuencia</b> 60 Hz	<b>Base</b> E27	<b>Material</b> Aspas de madera gris titano
-----------------------------------	----------------------------	--------------------	--

**Ventilador Ventum 30"**

**Modelo V3002**

**Inner -**

**Master**

**6 ASPAS**

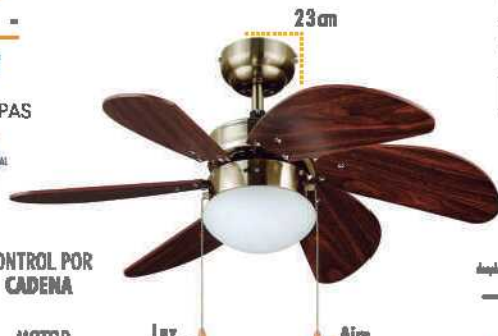

Aspas: 32cm



Diametro: 76 cm  
Peso: 5 kg aprox.

**110-127 V~**

**1 FOCO**  
No incluye foco

**110/160/230**  
3 velocidades

<b>Potencia del motor</b> 60 W	<b>Frecuencia</b> 60 Hz	<b>Base</b> E26	<b>Material</b> Latón antiguo aspas madera
-----------------------------------	----------------------------	--------------------	---

**NUEVO**

**Ventilador Ventall 42"**

**Modelo V4207**

**Inner -**

**Master I**

**4 ASPAS**



Aspas: 41 cm



Diametro: 106 cm  
Peso: 5 kg aprox.

**110-127 V~**

**1 FOCO**  
No incluye foco

**110/160/230**  
3 velocidades

<b>Potencia del motor</b> 60 W	<b>Frecuencia</b> 60 Hz	<b>Base</b> E26	<b>Material</b> Blanco y aspas blancas
-----------------------------------	----------------------------	--------------------	---

**NUEVO**

**Ventilador Ventall 42"**

**Modelo V4208**

**Inner -**

**Master I**

**4 ASPAS**



Aspas: 41 cm



Diametro: 106 cm  
Peso: 5 kg aprox.

**110-127 V~**

**1 FOCO**  
No incluye foco

**110/160/230**  
3 velocidades

<b>Potencia del motor</b> 60 W	<b>Frecuencia</b> 60 Hz	<b>Base</b> E26	<b>Material</b> Latón antiguo aspas madera
-----------------------------------	----------------------------	--------------------	---

\* Las imágenes mostradas en este catálogo son con fines ilustrativos.  
IGoto se reserva el derecho de modificar la información sin previo aviso y no se hace responsable por omisiones o errores en este documento.



**Ventilador Aria 42"**

**Modelo V4201**

**Inner - Master 1**

**5 ASPAS**



**CONTROL POR CADENA**

**MOTOR REFORZADO**



110-127 V~



**3 FOCOS**  
No incluye focos



110/160/200  
3 velocidades



Díametro: 106cm  
Peso: 5 kg aprox.

Potencia del motor	Frecuencia	Base	Material
60 W	60 Hz	E26	Níquel cromado aspas negras

**Ventilador Aria 42"**

**Modelo V4202**

**Inner - Master 1**

**5 ASPAS**



**CONTROL POR CADENA**

**MOTOR REFORZADO**



110-127 V~



**3 FOCOS**  
No incluye focos



110/160/200  
3 velocidades



Díametro: 106cm  
Peso: 5 kg aprox.

Potencia del motor	Frecuencia	Base	Material
60 W	60 Hz	E26	Níquel cromado aspas madera

**Ventilador Brezza 42"**

**Modelo V4203**

**Inner - Master 1**

**4 ASPAS**



**CONTROL POR CADENA**

**MOTOR REFORZADO**



110-127 V~



**1 FOCO**  
No incluye foco



110/160/210  
3 velocidades



Díametro: 106cm  
Peso: 5 kg aprox.

Potencia del motor	Frecuencia	Base	Material
60 W	60 Hz	E26	Níquel brillante aspas blancas

**Ventilador Brezza 42"**

**Modelo V4204**

**Inner - Master 1**

**4 ASPAS**



**CONTROL POR CADENA**

**MOTOR REFORZADO**



110-127 V~



**1 FOCO**  
No incluye foco



110/160/210  
3 velocidades



Díametro: 106cm  
Peso: 5 kg aprox.

Potencia del motor	Frecuencia	Base	Material
60 W	60 Hz	E26	Níquel cromado aspas gris



**Ventilador Vant 42"**

**Modelo V4205**

**Inner - Master 1**

**4 ASPAS**



**CONTROL POR CADENA**

**MOTOR REFORZADO**



Nivel de desplazamiento de aire



Aspas: 41cm



Diametro: 106cm  
Peso: 5 kg aprox.



110-127 V~



1 FOCO  
No incluye foco



105/160/210  
3 velocidades

Potencia del motor	Frecuencia	Base	Material
60 W	60 Hz	E26	Niquel brillante aspas negras

**Ventilador Vant 42"**

**Modelo V4206**

**Inner - Master 1**

**4 ASPAS**



**CONTROL POR CADENA**

**MOTOR REFORZADO**

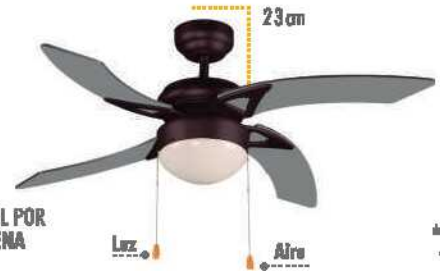

Nivel de desplazamiento de aire



Aspas: 41cm



Diametro: 106cm  
Peso: 5 kg aprox.



110-127 V~



1 FOCO  
No incluye foco



105/160/210  
3 velocidades

Potencia del motor	Frecuencia	Base	Material
60 W	60 Hz	E26	Negro y aspas gris



\* Las imágenes mostradas en este catálogo son con fines ilustrativos.  
¡Goto se reserva el derecho de modificar la información sin previo aviso y no se hace responsable por omisiones o errores en este documento.





# LÁMPARAS DE NOCHE MULTIFUNCIONALES



## Lámpara con sensor de movimiento

Modelo	Luz Cálida	Modelo	Luz Fría
LE01	3000 K	LE06	6500 K

### Potencia

1 w

Flujo  
30-40 lm

Inner 10

Master 40



Modo de uso:  
-Automático  
-Manual



Sensor de movimiento

3,000 k  
6,500 k



30,000 h



3 baterías  
No incluye



No requiere cableado  
- Cinta autoadherible



Ángulo del sensor 90°  
Distancia del sensor 3m

Tensión  
4,5 w

Baterías  
AA

Frecuencia  
60 Hz

Intensidad de corriente  
200 mA

2400-3000K

4100-5700K

6500-7000K

## Lámpara con contacto y salida USB

Modelo  
LE02

Potencia  
14 w

Flujo  
7 lm

Inner 4

Master 24



Atenuador touch  
para cambio de color:

Azul Amarillo Verde

Conexión USB

Contacto aterrizado

Sensor de movimiento



30,000 h



Salida USB  
5 V ~ 2.1 A



Contacto  
aterrizado



Conexión de  
cavija

Tensión  
120V

Frecuencia  
60 Hz

Salida socket  
3680w - 16V

Intensidad de corriente  
150 mA

# LÁMPARAS DE NOCHE LED

## Lámpara de noche multifuncional

**Modelo**  
**LE03**

**Potencia**  
**1w**

**Flujo**  
**30-40 lm**

**Inner** 1

**Master** 24

Largo: 3 cm

Anch: 5,8 cm



**4 Funciones en UNO**

- Sensor de movimiento
- Lámpara de emergencia
- Lámpara de noche
- Linterna



30,000 h



Clavija tipo bisagra



Ángulo del sensor 90° aproximadamente

**Características eléctricas**

110-120 V ~ 60 Hz 1,3 W 0,09A

**Batería recargable**

Li-ion 3,7 V 500 mAh

2400-3000E

4100-5700K

6500-7000K

## Lámpara con contacto y salida USB

**Modelo**  
**LE04**

**Potencia**  
**13,5 w**

**Flujo**  
**14 lm**

**Inner** 1

**Master** 24

Largo: 6,3 cm

Anch: 4,4 cm



30,000 h



Salida USB 5 V ~ 2.1 A



Contacto aterrizado



Conexión de clavija



Fácil instalación: - Clavija

**Tensión**

4,5 W

**Características eléctricas**

120 V ~ 60 Hz 16A 1920 W

2400-3000E

4100-5700K

6500-7000K

## Lámpara de baterías

**Modelo**  
**LE05**

**Potencia**  
**3 w**

**Flujo**  
**200 lm**

**Inner** 12

**Master** 72

Largo: 9 cm

Anch: 2 cm



30,000 h



3 baterías No incluye



No requiere cableado



Fácil instalación: -Imanes o velcro

**Voltaje**

4,5 V

**Características eléctricas**

6 V ~ 8,3 w 1,3 A

**Intensidad de corriente**

500 mA

2400-3000E

4100-5700K

6500-7000K

## Lámpara de baterías

**Modelo**  
**LE07**

**Potencia**  
**3 w**

**Flujo**  
**200 lm**

**Inner** 12

**Master** 72

Largo: 9 cm

Anch: 2 cm



30,000 h



3 baterías No incluye



No requiere cableado



Fácil instalación: -Imanes o velcro

**Voltaje**

4,5 V

**Características eléctricas**

6 V ~ 8,3 w 1,3 A

**Intensidad de corriente**

500 mA

2400-3000E

4100-5700K

6500-7000K

\* Las imágenes mostradas en este catálogo son con fines ilustrativos. Igoto se reserva el derecho de modificar la información sin previo aviso y no se hace responsable por omisiones o errores en este documento.





# ELIGE EL REFLECTOR IGOTO IDEAL



Luz con tecnología LED.



Tiempo aproximado de vida 30,000 horas.



Multivoltaje  
110-240 V~



Fácil instalación.

LOS REFLECTORES IGOTO ESTAN PROTEGIDOS CONTRA:



Objetos con diametro superior a 1mm



Aprueba de polvo.



Salpicaduras



Chorros de agua.

## AJUSTES



### Sensibilidad

El ángulo máximo del sensor es de 100°. La distancia máxima del sensor es de 8m, si señala a lo más grueso, mayor será el ángulo y distancia del sensor distancia



### Tiempo

El tiempo retardado del sensor es de 10-60 segundos, si apunta a lo más grueso mayor será el tiempo retardado del sensor.



### Modo de Trabajo

El ángulo máximo del sensor es de 100°, la distancia máxima del sensor es de 8m, si señala a lo más grueso, mayor será el ángulo y distancia del sensor distancia

## ESPACIOS RECOMENDADOS

### DOMESTICO



Jardín



Fachadas y exteriores



Terrazas

### OUTDOOR



Estadios deportivos



Zonas verdes



Estacionamientos

### ENTRETENIMIENTO



Conciertos



Museos



Acuarios

## REFLECTORES LED

### Reflector LED 16W

Modelo  
**RE01**

Potencia  
**16 w**

Flujo  
**500 lm**

Inner **1**

Master **4**



**MULTIVOLTAJE**  
PROTEGE TUS APARATOS



30,000 h



Fácil instalación



Luz dimmable  
20%-100%



Ángulo del sensor 100°  
Distancia del sensor 8m

Voltaje  
110-127 V~

Frecuencia  
60 Hz

Peso  
1,5 kg

-Incluye cable para corriente



### Reflector LED 16W

Modelo  
**RE03**

Potencia  
**16 w**

Flujo  
**500 lm**

Inner **1**

Master **4**



**MULTIVOLTAJE**  
PROTEGE TUS APARATOS



30,000 h



Fácil instalación



Luz dimmable  
20%-100%



Ángulo del sensor 100°  
Distancia del sensor 8m

Voltaje  
110-127 V~

Frecuencia  
60 Hz

Peso  
1,4 kg

-Incluye cable para corriente





**Reflector LED 30W**

**Modelo RE06**

**Potencia 30 w**

**Flujo 2000 lm**

**Inner 1**

**Master 4**



**MULTIVOLTAJE**  
PROTEGE TUS APARATOS

30,000 h	Fácil instalación	8-10 h	Ecológico	Ángulo del sensor 100° Distancia del sensor 4-10m
<b>Batería recargable</b> Li-ion 5200 mAh	<b>Panel solar</b> 5V~4W	<b>Peso</b> 1,2 kg		



**Reflector LED 10W**

**Modelo RE08**

**Potencia 10 w**

**Flujo 600 lm**

**Inner 10**

**Master 20**



**MULTIVOLTAJE**  
PROTEGE TUS APARATOS

30,000 h	Fácil instalación	8-10 h	Ecológico	Ángulo del sensor 100° Distancia del sensor 4-10m
<b>Batería recargable</b> Li-ion 5200 mAh	<b>Panel solar</b> 5V~4W	<b>Peso</b> 1,2 kg		



**Reflector LED 6,5W**

**Modelo RE09**

**Potencia 6,5 w**

**Flujo 220-380 lm**

**Inner 1**

**Master 4**



**MULTIVOLTAJE**  
PROTEGE TUS APARATOS

30,000 h	Fácil instalación	3 baterías No incluye	Ecológico	Ángulo del sensor 100° Distancia del sensor 1-8m
<b>3 baterías AA</b> 220 lm	<b>6 baterías AA</b> 380 lm	<b>Peso</b> 800 gr		



# igoto<sup>®</sup>

SWISS<sup>®</sup>



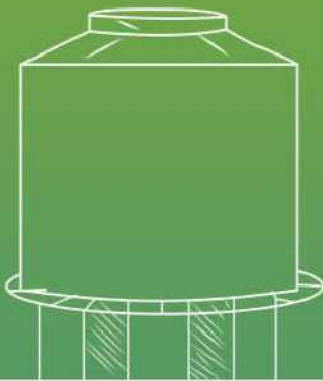

# igoto

PUMPS<sup>®</sup>

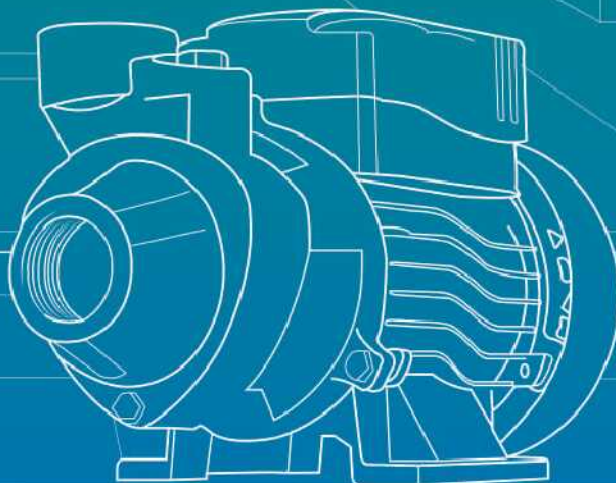



# igoto

PUMPS®



## BOMBA PRESURIZADOR

¡Disfruta de un buen baño!  
Aumenta la presión del agua con nuestros presurizadores.

## BOMBA PERIFÉRICA

¡Lleva el agua a donde tú quieras!  
Máxima presión en edificios e instalaciones altas.

## BOMBA CENTRÍFUGA

¿Necesitas más agua?  
Obtén grandes cantidades con nuestras bombas centrífugas.

## SOLDADORA MINI Y PLUS

Ideal para trabajo industrial ligero.

## BOMBA TIPO BALA

Obten agua desde lugares profundos.

## BOMBA SUMERGIBLE

Presión constante desde la cisterna a tu hogar.



**MAYOR POTENCIA**

20µF

**EMBOBINADO DE COBRE**  
MEJOR CONDUCCIÓN Y MENOS CALENTAMIENTO

**IMPULSOR DE BRONCE**  
MAYOR DURABILIDAD, FLUJO CONSTANTE



## Bomba Periférica

### APLICACIONES:



Doméstico



Agrícola



Aspersores



Llenado de tinaco



Llenado de alberca

### VENTAJAS:

#### MÁXIMA PRESIÓN DE AGUA A GRANDES ALTURAS

- 1- Mejor conducción y menos calentamiento
- 2- Mayor durabilidad y flujo constante
- 3- Evita que la bomba se pegue y mantiene su alto rendimiento

Altura Máxima hasta 60 m



EMBOBINADO EN COBRE  
MEJOR CONDUCCIÓN Y MENOS CALENTAMIENTO

IMPULSOR DE BRONCE  
MAYOR DURABILIDAD, FLUJO CONSTANTE

MAYOR FLUJO DE AGUA

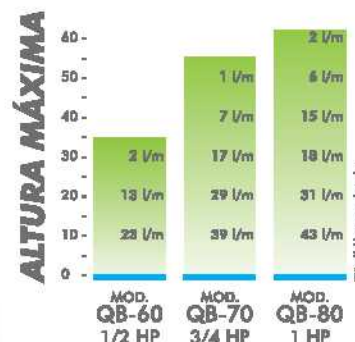

IDEAL PARA TANQUE HIDROPNEUMÁTICO

MODELO	Potencia HP	W	Motor	A. Max (m)	C. Max (l/m)	Conexiones Succ.	Des.	Capacitor	Corriente Eléctrica	Peso
QB-60	1/2	370	1 F 127 V~	35	35	1"	1"	20 µF	3.5 A	5.5 kg
QB-70	3/4	550	1 F 127 V~	55	55	1"	1"	30 µF	7.2 A	8.8 kg
QB-80	1	750	1 F 127 V~	60	60	1"	1"	40 µF	11 A	9 kg

## Bomba Periférica DUO

### APLICACIONES:



Doméstico



Agrícola



Aspersores



Llenado de tinaco

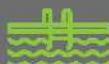

Llenado de alberca

### VENTAJAS:

#### MAYOR FLUJO DE AGUA

- 1- Embobinado con protección térmica
- 2- Mayor durabilidad y flujo constante
- 3- Evita que la bomba se pegue y mantiene su alto rendimiento

Altura Máxima hasta 33 m



IMPULSOR DE BRONCE  
MAYOR DURABILIDAD, FLUJO CONSTANTE

Embobinado con PROTECCIÓN TÉRMICA

DUO

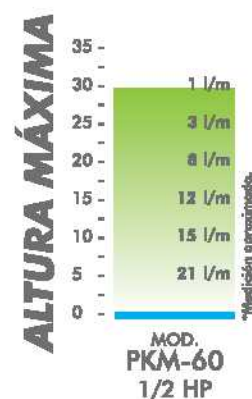

IDEAL PARA TANQUE HIDROPNEUMÁTICO

MODELO	Potencia HP	W	Motor	A. Max (m)	C. Max (l/m)	Conexiones Succ.	Des.	Capacitor	Corriente Eléctrica	Peso
PKM-60	1/2	370	1 F 127 V~	33	31	1"	1"	20 µF	3.5 A	3.5 kg





## Bomba Periférica DUO

Altura Máxima hasta 24 m

**DUO**



### APLICACIONES:



Doméstico



Agrícola



Aspersores



Llenado de tinaco



Llenado de alberca

### VENTAJAS:

#### MAYOR FLUJO DE AGUA

- 1- Embobinado con protección térmica
- 2- Mayor durabilidad y flujo constante
- 3- Evita que la bomba se pegue y mantiene su alto rendimiento



ALtura MÁXIMA



MOD. PE-60  
1/2 HP

**IMPULSOR DE BRONCE**  
MAYOR DURABILIDAD, FLUJO CONSTANTE



Embobinado con PROTECCIÓN TÉRMICA

MODELO	Potencia HP	W	Motor	A. Max (m)	C. Max (l/m)	Conexiones Succ.	Des.	Capacitor	Corriente Eléctrica	Peso
PE-60	1/2	370	1 F 127 V~	24	32	1"	1"	20 µF	3.5 A	3.5 kg

## Bomba Autocebante

Altura Máxima hasta 45 m

**MAYOR FLUJO DE AGUA**



### APLICACIONES:



Doméstico



Agrícola



Aspersoras



Llenado de tinaco



Llenado de alberca

### VENTAJAS:

#### IDEAL PARA BOMBEO Y ASPIRACIÓN SIN MAYOR MANTENIMIENTO

- 1- Mejor conducción y menos calentamiento
- 2- Mayor durabilidad y flujo constante



ALtura MÁXIMA

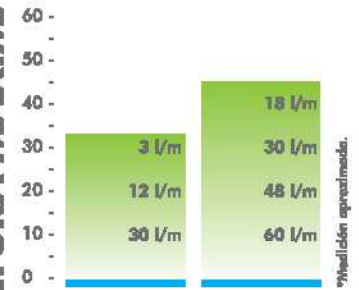

MOD. AT60  
1/2 HP

MOD. AT80  
1 HP

**IMPULSOR DE BRONCE**  
MAYOR DURABILIDAD, FLUJO CONSTANTE



MODELO	Potencia HP	W	Motor	A. Max (m)	C. Max (l/m)	Conexiones Succ.	Des.	Capacitor	Corriente Eléctrica	Peso
AT60	1/2	370	1 F 127 V~	33	30	1"	1"	25 µF	5.2 A	7.5 kg
AT80	1	750	1 F 127 V~	45	50	1"	1"	35 µF	10.8 A	10.8 kg





## Bomba JET

### APLICACIONES:



Doméstico



Agrícola



Aspersores



Llenado de tinaco



Llenado de alberca

### VENTAJAS:

**MÁXIMO CAUDAL Y PRESIÓN EN UN SOLO PRODUCTO**

- 1- Mayor durabilidad
- 2- Flujo constante
- 3- Evita que la bomba se pegue y mantiene su alto rendimiento

Altura Máxima hasta 52 m



**CABEZAL y FLECHA DE ACERO INOXIDABLE**  
MAYOR DURABILIDAD

**IMPULSOR DE PLÁSTICO**  
FLUJO CONSTANTE

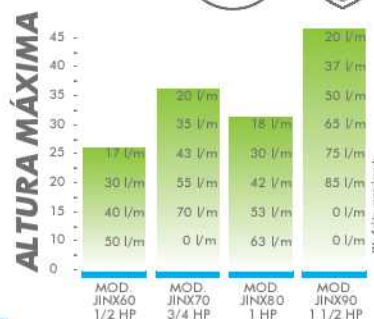

MODELO	Potencia HP	W	Motor	A. Max (m)	Rango operación H(m)	Q(l/m)	Conexiones Succ.	Des.	Capacitor	Corriente Eléctrica	Peso
JINX60	1/2	370	1 F 127 V~	38	8-27	41-5	1"	1"	30 µF	4.7 A	7.4 kg
JINX70	3/4	550	1 F 127 V~	40	10-32	44-5	1"	1"	40 µF	8.7 A	7.8 kg
JINX80	1	750	1 F 127 V~	44	10-36	48-5	1"	1"	50 µF	9.5 A	8.5 kg
JINX90	1 1/2	1100	1 F 127 V~	52	10-40	51-5	1"	1"	50 µF	11 A	9.2 kg

## Bomba Centrífuga DUO

### APLICACIONES:



Doméstico



Agrícola



Aspersores



Llenado de tinaco



Llenado de alberca

### VENTAJAS:

**MÁXIMO CAUDAL A GRANDES ALTURAS**

- 1- Embobinado con protección térmica
- 2- Mayor durabilidad y flujo constante
- 3- Evita que la bomba se pegue y mantiene su alto rendimiento

Altura Máxima hasta 32 m



Embobinado con **PROTECCIÓN TÉRMICA**

**IMPULSOR DE BRONCE**  
MAYOR DURABILIDAD, FLUJO CONSTANTE

**DUO**

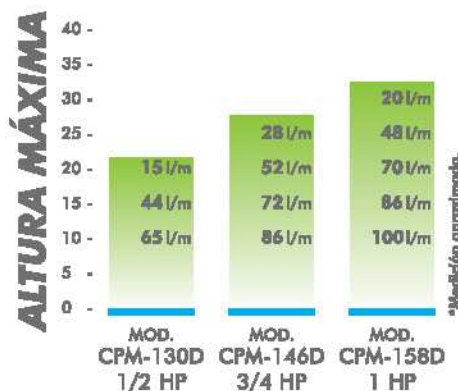

MODELO	Potencia HP	W	Motor	A. Max (m)	Rango operación H(m)	Q(l/m)	Conexiones Succ.	Des.	Capacitor	Corriente Eléctrica	Peso
CPM-130D	1/2	370	1 F 127 V~	22	20-6	18-80	1"	1"	25 µF	4.5 A	9.2 kg
CPM-146D	3/4	550	1 F 127 V~	28	26-8	23-92	1"	1"	35 µF	7.2 A	12 kg
CPM-158D	1	750	1 F 127 V~	32	30-10	18-100	1"	1"	45 µF	9.8 A	13 kg

\* Las imágenes mostradas en este catálogo son con fines ilustrativos.

IGota se reserva el derecho de modificar la información sin previo aviso y no se hace responsable por omisiones o errores en este documento.



**Motobomba**

**APLICACIONES:**



Agrícola



Pipa de agua



Uso con gasolina

**VENTAJAS:**

**IDEAL PARA AGUA LIMPIA Y REGAR CULTIVOS**

1- Asegura la durabilidad de tus aparatos.

Altura Máxima hasta 32 m

**MAYOR FLUJO DE AGUA**



Uniones para manguera de **Aluminio**

Altura máxima **32 m** 

Succión máxima **8 m** 

MODELO	Potencia HP	Velocidad de motor	A. Max (m)	C. Max (l/m)	Conexión de entrada	Conexión de salida	Succión máxima	Capacidad del tanque
MAG2	6.5	3600 rpm	32	800	5 cm 2"	5 cm 2"	8 m	3.6 L
MAG3	6.5	3600 rpm	30	1200	7.6 cm 3"	7.6 cm 3"	8 m	3.6 L
MAG4	7	3600 rpm	25	1600	10 cm 4"	10 cm 4"	8 m	3.6 L

**AUTOMÁTICOS Y PRESURIZADORES**

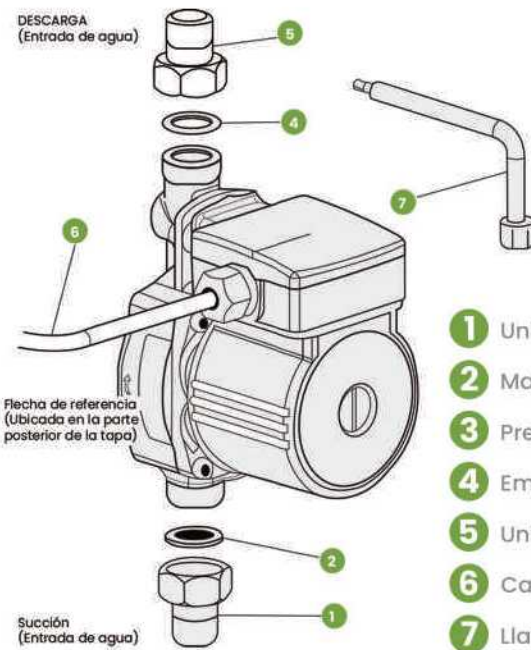

- 1 Unión y tuerca
- 2 Malla cedazo
- 3 Presurizador
- 4 Empaque
- 5 Unión y tuerca
- 6 Cable de alimentación
- 7 Llave

**POSICIONES CORRECTAS DE INSTALACIÓN**



**POSICIONES INCORRECTAS DE INSTALACIÓN**



**USOS**





## Presurizadores Automáticos

### APLICACIONES:



### VENTAJAS:

#### AUMENTA LA PRESIÓN DEL AGUA

- 1- Mejor conducción y menos calentamiento
- 2- Interruptor de presión de paro automático
- 3- Máximo ahorro de energía
- 4- Silencioso

### Altura Máxima hasta 12 m



PAC16\*

PAC21

**EMBOBINADO EN COBRE**  
MEJOR CONDUCCIÓN Y MENOS CALENTAMIENTO

**SE ACTIVA CON EL FLUJO DE AGUA**



**INCLUYE CABLE**

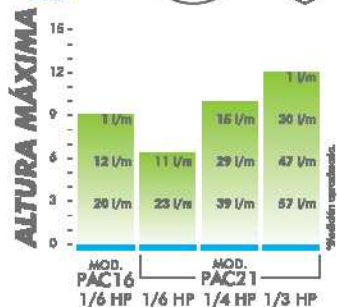

MODELO	Potencia HP	Potencia W	Motor	Clase de aislamiento	A. Max (m)	C. Max (l/m)	Conexiones Succ.	Conexiones Des.	Temperatura máxima	Corriente Eléctrica	Peso
PAC16	1/6	140	1 F 127 V~	F	9	27	3/4"	3/4"	90°C	1 A	2.5 kg
PAC21	1/6	140	1 F 127 V~	F	7	30	1"	1"	90°C	3.5 A	5 kg
	1/4	210	1 F 127 V~		10.5	41	1"	1"			
	1/3	245	1 F 127 V~		12	58	1"	1"			

## Automático para bomba de agua

### IDEAL PARA BOMBAS:

PKM-60 QB-60 QB-70  
QB-80 CPM-158D



Bombas con mínimo 3kg de presión.



Ciclo de trabajo continuo. Siempre y cuando cumpla con las condiciones óptimas de trabajo (agua y voltaje)

### VENTAJAS:

#### MÁXIMA PRESIÓN AL ABRIR EL GRIFO DEL AGUA

- 1- Asegura la durabilidad de tus aparatos.
- 2- Regula el flujo de agua
- 3- Función automática o manual



AMC-2.1

AMC-10

AMC-12

**MULTI VOLTAJE 85 - 240 V ~**  
EVITA SOBRECARGAS



PRESIÓN AJUSTABLE

**SE ACTIVA CON EL FLUJO DE AGUA**

**INCLUYE CABLE**

MODELO	Potencia HP	Potencia W	Motor	Rango de operación	Temperatura máxima	Conexiones Succ.	Conexiones Des.	Corriente eléctrica	Peso
AMC-2.1	1	750	85-240 V~	17-36 PSI	90°C	1"	1"	10 A	1.17 kg
AMC-10	1	750	85-240 V~	17-36 PSI	90°C	1"	1"	10 A	0.98 kg
AMC-12	1	750	85-240 V~	17-36 PSI	90°C	1"	1"	10 A	1.17 kg

\* Las imágenes mostradas en este catálogo son con fines ilustrativos. iGoto se reserva el derecho de modificar la información sin previo aviso y no se hace responsable por omisiones o errores en este documento.





Tanque Hidroneumático

MÁXIMA PRESIÓN EN TODAS LAS SALIDAS DE AGUA.

IDEAL PARA BOMBAS:

PKM-60 QB-60 QB-70 QB-80



Almacenaje de agua



Mantenimiento continuo

INCLUYE:

- 1 - Manómetro
- 1 - Conector
- 1 - Automático
- 1 - Manguera Flexible



INCLUYE KIT:



MANÓMETRO



CONECTOR



AUTOMÁTICO



MANGUERA FLEXIBLE

MODELO	Capacidad real	Conexión	Presión máxima	Peso
TH-24	21 L	G1	8,16 kg/s <sup>2</sup> =116 PSI	5.5 kg
TH-50	43 L	G1	8,16 kg/s <sup>2</sup> =116 PSI	7.7 kg
TH-100	93 L	G1	8,16 kg/s <sup>2</sup> =116 PSI	14 kg

Tanques Armados

IDEAL PARA BOMBAS:

PKM-60 QB-70

Altura Máxima hasta 60 m



↑ ALTURA MÁXIMA HASTA 30 m

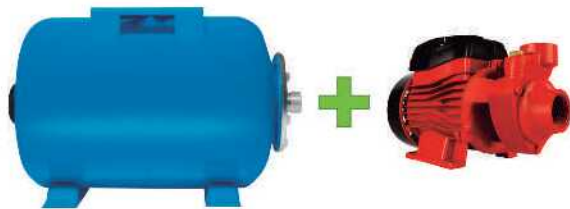

TH24 + PKM60 = HA370

↑ ALTURA MÁXIMA HASTA 60 m

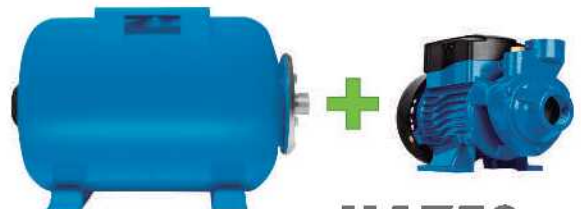

TH50 + QB70 = HA750

MODELO	Tanque	Bomba	Potencia	Capacidad real	Altura máxima	Conexión
HA370	TH24	PKM60	1/2 HP	21 L	30 m	G1
HA750	TH50	QB70	3/4 HP	43 L	60 m	G1



**Bomba para fuentes\***

**APLICACIONES:**



Circulación del agua



Fuentes



Comercial



Doméstico



Dranaje

**VENTAJAS:**

**FUNCIONAMIENTO EFICAZ Y CONSTANTE**

- 1- Motor con polos protegidos contra sobrecarga
- 2- Graduación de la temperatura del líquido
- 3- Pantalla de entrada extraíble para mejor limpieza

Altura Máxima hasta 8 m



**ALTURA MÁXIMA**

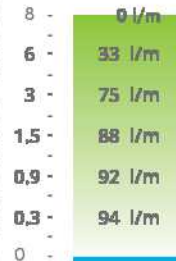

\*Medición aproximada

MOD. BF195  
1/6 HP

MODELO	Potencia HP	W	Motor	PSI	A. Max (m)	C. Max (l/m)	Ampers FLA	Ampers del disyuntor	Peso
BF195	1/6	124	127 V~	11.4	8	76	2.0	15 A	3.4 kg

**Bomba sumergible de acero inoxidable**

**APLICACIONES:**



Doméstico



Agrícola



Aspersores



Llenado de tinaco



Llenado de alberca

**VENTAJAS:**

**PRESIÓN CONSTANTE A MÁXIMA ALTURA**

- 1- Mejor conducción y menos calentamiento
- 2- Protege tu bomba contra el sobrecalentamiento.
- 3- Sumergible 13 m máximo

Altura Máxima hasta 40 m



**ALTO DESEMPEÑO**



**ALTURA MÁXIMA**

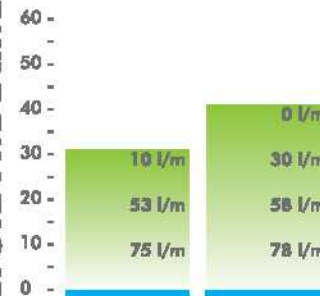

\*Medición aproximada.

MOD. Q800  
1 HP

MOD. Q1000  
1.3 HP

**EMBOBINADO DE COBRE**  
MEJOR CONDUCCIÓN Y MENOS CALENTAMIENTO

INCLUIVE ADAPTADOR DE MANGUERA

INCLUIVE FLOTADOR

10 METROS DE CABLE

MODELO	Potencia HP	W	Impulsores	A. Max (m)	C. Max (l/m)	Range operación H(m) Q(l/m)	Conexiones Succ.	Des.	Capacitor	Corriente eléctrica	Peso
Q800	1	750	3	30	296	5-14 296-33	1"	1"	35 µF	6 A	7.6 kg
Q1000	1.3	1100	4	40	329	7-15 329-50	1"	1"	35 µF	8 A	8.1 kg

\* Las imágenes mostradas en este catálogo son con fines ilustrativos.

IGoto se reserva el derecho de modificar la información sin previo aviso y no se hace responsable por omisiones o errores en este documento.







Bomba sumergible plástica

APLICACIONES:

Agua limpia o turbia	No paso sólido	Grado alimenticio
No estacionaria	Químicos: -Hipocloritos -Sosa caustica	Llenado de cisterna

VENTAJAS:

IDEAL PARA VACIAR O BOMBEAR GRANDES CANTIDADES DE AGUA

- 1- Embobinado con protección térmica
- 2- Protege tu bomba contra el sobrecalentamiento.
- 3- Sumergible 13 m máximo

Altura Máxima hasta 10 m



ALTO DESEMPEÑO

EMBOBINADO EN COBRE  
MEJOR CONDUCCIÓN Y MENOS CALENTAMIENTO

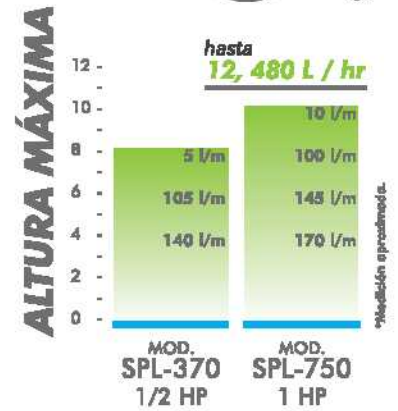
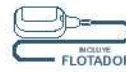

MODELO	Potencia HP	W	Motor	A. Max (m)	A. Max (l/m)	Descarga	Capacitor	Corriente eléctrica	Peso
SPL-370	1/2	370	1 F 127 V~	8	175	3/4-1" - 1/2"	10 µF	4.4 A	4.3 kg
SPL-750	1	750	1 F 127 V~	10	203	3/4-1" - 1/2"	16 µF	6.5 A	5.1 kg

Bomba sumergible para agua turbia

APLICACIONES:

Carcama	Agrícola	Construcción
---------	----------	--------------

Paso sólido 4mm	No basura
-----------------	-----------

VENTAJAS:

MAYOR FLUJO DE AGUA

- 1- Mejor conducción y menos calentamiento
- 2- Mayor durabilidad y flujo constante
- 3- Protege tu bomba contra el sobrecalentamiento
- 4- Sumergible 13 m máximo

Altura Máxima hasta 18 m



Sólida adaptable: -1.5" a 2"

EMBOBINADO EN COBRE  
MEJOR CONDUCCIÓN Y MENOS CALENTAMIENTO

IMPULSOR METALICO  
FLUJO CONSTANTE

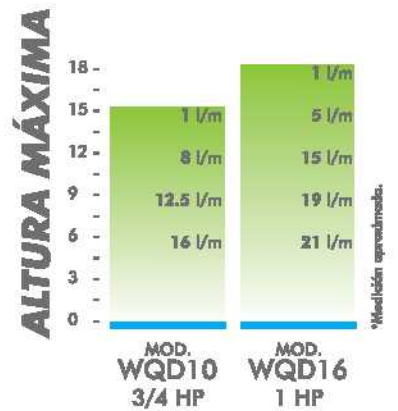

MODELO	Potencia HP	W	A. Max (m)	Descarga	Rango operación H(m)	Q(l/m)	Corriente eléctrica	Capacitor	Peso
WQD10	3/4	550	15	1.5"	5 - 14	296 - 33	10.6 A	40 µF	14 kg
WQD16	1	750	18	1.5"	7 - 15	329 - 50	12.7 A	50 µF	17 kg





**Bomba sumergible**

**APLICACIONES:**



Doméstico



Agrícola



Aspersoras



Llenado de tinaco



Llenado de alberca

**VENTAJAS:**

**PRESIÓN CONSTANTE DESDE LA CISTERNA A TU HOGAR**

- 1- Embobinado con protección térmica
- 2- Flujo constante
- 3- Sumergible 13 m máximo

Altura Máxima hasta 33 m



QDX CON FLOTADOR



QDX SIN FLOTADOR

**EMBOBINADO DE COBRE**  
MEJOR CONDUCCIÓN Y MENOS CALENTAMIENTO

**IMPULSOR METÁLICO**  
FLUJO CONSTANTE

8 METROS DE CABLE

**ALTURA MÁXIMA**

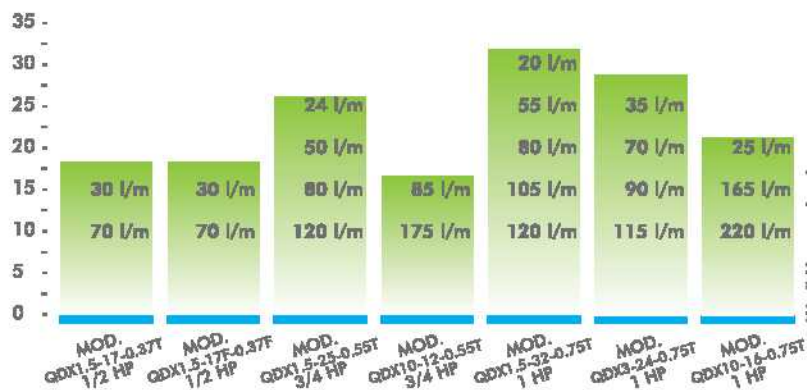

**INCLUYE FLOTADOR**

MODELO	Potencia HP W	Motor	A. Max (m)	Rango operación H(m)	Rango operación Q(l/m)	Descarga	Capacitor	Corriente eléctrica	Peso
QDX1.5-17F-0.37T	1/2 370	1 F 127 V~	18.5	17 ÷ 6	17 ÷ 85	1"	25 µF	6.4 A	11.8 kg
QDX10-12-0.55T	3/4 550	1 F 127 V~	17.5	15 ÷ 6.5	100 ÷ 218	1 1/2"	40 µF	10 A	16.7 kg
QDX3-24-0.75T	1 750	1 F 127 V~	28	26 ÷ 12	52 ÷ 115	1 1/2"	50 µF	11.8 A	16.5 kg
QDX10-16-0.75T	1 750	1 F 127 V~	20.3	18 ÷ 7	130 ÷ 260	2"	50 µF	11.8 A	17.7 kg

**SIN FLOTADOR**

MODELO	Potencia HP W	Motor	A. Max (m)	Rango operación H(m)	Rango operación Q(l/m)	Descarga	Capacitor	Corriente eléctrica	Peso
QDX1.5-17-0.37T	1/2 370	1 F 127 V~	18.5	17 ÷ 6	17 ÷ 85	1"	25 µF	6.4 A	11.6 kg
QDX1.5-25-0.55T	3/4 550	1 F 127 V~	25	24 ÷ 11.5	18 ÷ 110	1"	40 µF	10 A	15.6 kg
QDX1.5-32-0.75T	1 750	1 F 127 V~	33	32 ÷ 12.7	17 ÷ 112	1"	50 µF	11.8 A	17.9 kg

\* Las imágenes mostradas en este catálogo son con fines ilustrativos. ¡Goto se reserva el derecho de modificar la información sin previo aviso y no se hace responsable por omisiones o errores en este documento.



# BOMBAS SUMERGIBLES/TIPO BALA

VENTAJAS	Encendido rápido, no requiere cebado.	Resistentes Larga duración.	Silenciosas
USOS	Doméstico	Agrícola	Urbano
	Construcción	Llenado de tinaco	Aspersores

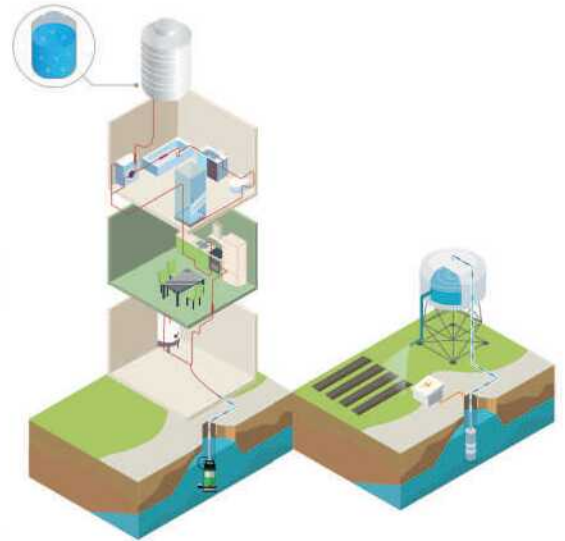

## Bomba sumergible Tipo bala con capacitor interno

Altura Máxima hasta 10 m



### APLICACIONES:

Doméstico	Agrícola	Urbano
Llenado de tinaco	Ideal para pozo	

### VENTAJAS:

**IDEAL PARA VACIAR O BOMBEAR GRANDES CANTIDADES DE AGUA**

- 1- Embobinado con protección térmica
- 2- Protege tu bomba contra el sobrecalentamiento.
- 3- Sumergible 13 m máximo



**NUEVO**



**EMBOBINADO EN COBRE**  
MEJOR CONDUCCIÓN Y MENOS CALENTAMIENTO

8 METROS DE CABLE

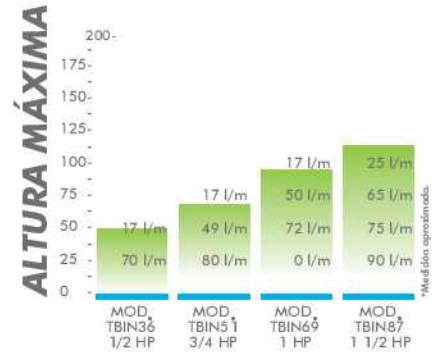

MODELO	Potencia HP	W	Motor	A. Max (m)	C. Max (l/m)	Conexiones Succ. Des.	Capacitor	Corriente eléctrica	Peso
TBIN36	1/2	370	1 F 127 V~	50	17	1/4"	35 µF	5 A	10.5 kg
				39	50				
				14	83				
TBIN51	3/4	550	1 F 127 V~	70	17	1/4"	45 µF	8 A	11.4 kg
				54	50				
				20	83				
TBIN69	1	750	1 F 127 V~	90	17	1/4"	60 µF	11 A	12.9 kg
				76	50				
				26	83				
TBIN87	1 1/2"	1100	1 F 127 V~	111	83	1/4"	70 µF	14 A	15 kg
				111	17				
				85	50				





**Bomba sumergible Tipo Bala**

**APLICACIONES:**



**VENTAJAS:**

**IDEAL PARA VACIAR O BOMBPEAR GRANDES CANTIDADES DE AGUA**

- 1- Embobinado con protección térmica
- 2- Protege tu bomba contra el sobrecalentamiento.
- 3- Sumergible 13 m máximo

Altura Máxima hasta 192 m



TBA36



TBA220

MOTOR REBOBINABLE  
BAÑADO EN ACEITE

EMBOBINADO  
de **COBRE**  
MEJOR CONDUCCIÓN  
Y MENOS CALENTAMIENTO



MODELO	Potencia HP	W	Motor	A. Max (m)	C. Max (l/m)	Conexiones Succ. Des.	Capacitor	Corriente eléctrica	Peso
TBA36	1/2	370	1 F 127 V~	50	17	1/4"	35 µF	5 A	10.5 kg
				39	50				
				14	83				
TBA51	3/4	550	1 F 127 V~	70	17	1/4"	45 µF	8 A	11.4 kg
				54	50				
				20	83				
TBA69	1	750	1 F 127 V~	90	17	1/4"	60 µF	11 A	12.9 kg
				76	50				
				26	83				
TBA87	1 1/2"	1100	1 F 127 V~	111	17	1/4"	70 µF	14 A	15 kg
				85	50				
				31	83				

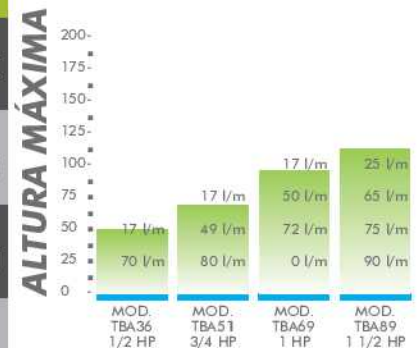

MODELO	Potencia HP	W	Motor	A. Max (m)	C. Max (l/m)	Conexiones Succ. Des.	Capacitor	Corriente eléctrica	Peso
TBA220-1.5	1.5	1.1	220 V~	85	50	1/4"	40 µF	6 A	- kg
				31	83				
TBA220-2	2	1.5	220 V~	131	17	1/4"	50 µF	8 A	- kg
				100	50				
				37	83				
TBA220-2	3	2.2	220 V~	195	17	1/4"	70 µF	14 A	- kg
				149	50				
				56	83				

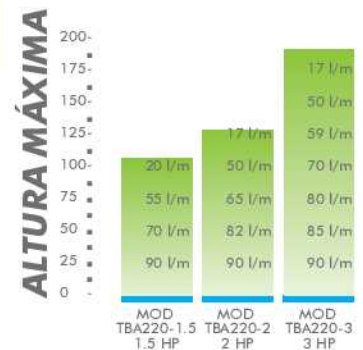

\* Las imágenes mostradas en este catálogo son con fines ilustrativos. IGoto se reserva el derecho de modificar la información sin previo aviso y no se hace responsable por omisiones o errores en este documento.







# SOLDADORAS TIPO INVERSORA MULTIFUNCIONALES



## Soldadora tipo inversora

### TIPO DE ELECTRODOS

- Revestido - Microalambre - Tungsteno

5/5

5 minutos de trabajo continuo  
por 5 minutos de descanso

### VENTAJAS:

- 1- Aprovechamiento de energía
- 2- Convierte corriente alterna a corriente directa

### INCLUYE:

- 1- Soldadora tipo Inversora
- 1- Cable con pinza porta electrodo
- 1- Cable con pinza conexión a tierra
- 1- Careta para soldar
- 1- Cepillo de alambre
- Manual de usuario

**MINI-130** - Uso amateur

**MINI-200** - Uso semiprofesional

Ideal para trabajo industrial ligero



**MULTI VOLTAJE**  
110 - 240 V ~  
EVITA SOBRECARGAS



ÚTIL PARA  
SOLDADURAS DE  
HASTA 3,2 mm

MODELO	Corriente directa	Rango de carga	Voltaje de carga	Ciclo de trabajo	Eficiencia	Factor de poder	Tipo de aislamiento	Peso
MINI-130	130 A	30-130 A	67 V ~	50%	80%	0,93	F	4 kg
MINI-200	200 A	30-200 A	67 V ~	50%	80%	0,93	F	5.5 kg



**Soldadora tipo inversora plus**

Ideal para trabajo industrial **modero**



**TIPO DE ELECTRODOS**

- Revestido - Microalambre
- Tungsteno



5 minutos de trabajo continuo por 5 minutos de descanso

**VENTAJAS:**

- 1- Aprovechamiento de energía
- 2- Convierte corriente alterna a corriente directa

**INCLUYE:**

- 1- Soldadora tipo inversora
- 1- Cable con pinza porta electrodo
- 1- Cable con pinza conexión a tierra
- 1- Careta para soldar
- 1- Capillo de alambre
- Manual de usuario

**NUEVO**



PLUS-130



PLUS-200



MODELO	Corriente directa	Rango de carga	Voltaje de carga	Cdo de trabajo	Eficiencia	Factor de poder	Tipo de aislamiento	Peso
PLUS-130	130 A	30-130 A	67 V ~	50%	80%	0,93	F	4 kg
PLUS-200	200 A	30-200 A	67 V ~	50%	80%	0,93	F	5.5 kg

**Careta electrónica**

**Careta Electrónica de Oscurecimiento Automático**

**Protección UV / IR**

Batería **Li-Ion**  
Carga mediante celdas solares

ENCENDIDO Y APAGADO **ELECTRÓNICO**



CRT360  
Recargable via USB



MODELO	Protección	Nivel de sombra	Sensores de arco	Ideal para soldaduras	Velocidad de retardo	Peso
CRT01	UV/IR	DIN 11	2	TIG/MIG/MAG	0,2-0,5 s	0,46 kg
CRT02	UV/IR	DIN 9-13	2	TIG/MIG/MAG	0,2- 1 s	0,47 kg
CRT03	UV/IR	DIN 9-13	2	TIG/MIG/MAG	0,2- 1 s	0,47 kg
CRT11	UV/IR	DIN 9-13	2	TIG/MIG/MAG	0,2- 1 s	0,46 kg
CRT12	UV/IR	DIN 9-13	2	TIG/MIG/MAG	0,2- 1 s	0,46 kg
CRT13	UV/IR	DIN 9-13	2	TIG/MIG/MAG	0,2- 1 s	0,46 kg
CRT360	UV/IR	DIN 5-8/9-13	4	TIG	0,2- 1 s	0,57 kg

\* Las imágenes mostradas en este catálogo son con fines ilustrativos. IGoto se reserva el derecho de modificar la información sin previo aviso y no se hace responsable por omisiones o errores en este documento.







## Flotador con contra peso



Policarbonato

Cable de cobre

Frecuencia 60 Hz

MODELO	Longitud manguera	Corriente eléctrica	Peso
FPS-2	2 m	16 A	0.3 kg
FPS-3	3 m	16 A	0.6 kg
FPS-6	6 m	16 A	0.9 kg
FPS-10	10 m	16 A	1.2 kg

## Control automático para bomba de agua



R-AMC-2.1



R-AMC-10



R-AMC-12

MODELO	Descripción	Apto para
R-AMC-2.1	Refacción pastilla AMC-2.1	AMC-2.1
R-AMC-10	Refacción pastilla AMC-10	AMC-10
R-AMC-12	Refacción pastilla AMC-12	AMC-12

## Impulsor para bomba centrífuga y pérfica



MODELO	Apto para	MODELO	Apto para
REF-04	CPM130D	REF-18	QB60
REF-05	CPM146D	REF-19	QB70
REF-06	CPM158D	REF-41	QB80

## Impulsor para bomba sumergible



MODELO	Capacidad	MODELO	Capacidad
REF-20	QDX17	REF-23	QDX32
REF-21	QDX25	REF-24	QDX24
REF-22	QDX12	REF-25	QDX16



## Membrana EPDM



MODELO	Apto para
REF-33	Tanque 24 L



MODELO	Apto para
REF-34	Tanque 50 L



MODELO	Apto para
REF-35	Tanque 100 L

## Conector



MODELO
REF-01

## Manómetro



MODELO
REF-36

## Tapa capacitor para PK60



MODELO
REF-29

## Control automático para tanque hidroneumático



MODELO	Motor	Rango operación	Corriente eléctrica	Entrada conexión
AMH-2	85-240 V~	20-40 PSI	16 A	1/4"

## Manguera flexible



MODELO	Medida
REF-03	60 cm



## Ventilador

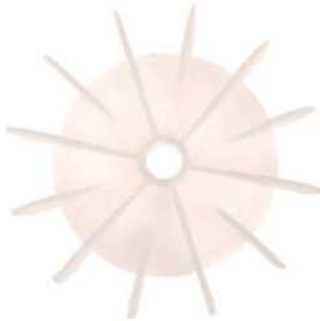

MODELO	Apto para
REF-07	QB60,PKM60,CPM-130
REF-08	QB70,QB80
REF-09	CPM146,CPM158

## Tapa capacitor para PKM60



MODELO	Capacidad
REF-30	JINX60
REF-31	JINX70
REF-32	JINX80, JINX90

## Capacitor



MODELO	Capacidad	MODELO	Capacidad
REF-10	20 $\mu$ F	REF-13	25 $\mu$ F
REF-11	30 $\mu$ F	REF-14	35 $\mu$ F
REF-12	40 $\mu$ F	REF-15	45 $\mu$ F

## Balero



MODELO	Apto para
REF-26	QB70 y QB80
REF-27	QB60,QDX17,CPM-130 AT60
REF-28	QDX25,QDX12,CPM-146 CPM-158, AT80, QDX32 QD16

## Sello mecánico



MODELO	Apto para
REF-16	QB60,QB70,PKM60,CPM-130
REF-17	CPM-146,CPM-158

## Caja de control



MODELO	Apto para
REF-37	TBA-36
REF-38	TBA-51
REF-39	TBA-69
REF-40	TBA-87
REF-41	TBA-220-1.5
REF-42	TBA-220-2
REF-43	TBA-220-3



---

ILUMINACIÓN/PLACAS/ARTEFACTOS/MECANISMOS/BOMBAS

---